

ST 500 "PIRANHA"

MULTIFUNCTIONAL DETECTION DEVICE



USER MANUAL

CONTENTS

1	<u>GENERAL INFORMATION</u>	3
1.1	<u>Purpose and Capabilities</u>	3
1.2	<u>Specification</u>	4
1.3	<u>Description of Specification Items</u>	5
1.4	<u>Power Supply</u>	8
1.5	<u>Technical Specifications</u>	9
2	<u>INTERFACE OPTIONS</u>	10
2.1	<u>Turning the Device On/Off</u>	10
2.2	<u>Main Menu</u>	10
2.3	<u>Status Bar</u>	11
2.4	<u>SETTINGS Service Mode</u>	11
2.4.1	Setting the Date	12
2.4.2	Setting the Time	12
2.4.3	Setting the Language	12
	TECHNICAL DESCRIPTION	
3	<u>SELECTIVE HF DETECTOR Channel</u>	13
3.1	<u>PANORAMA Mode</u>	13
3.2	<u>DIFFERENTIAL Mode</u>	15
3.2.1	<u>FIXED FREQUENCY ANALYSIS Function</u>	16
3.2.2	<u>SET "0" Function</u>	17
3.2.3	<u>OSCILLOSCOPE Function</u>	18
3.3	<u>AUTOMATED Mode</u>	19
3.3.1	<u>FREQUENCY TUNING Function</u>	20
3.3.2	<u>OSCILLOSCOPE Function</u>	21
3.4	<u>WIRELESS COMMUNICATION Mode</u>	21
3.4.1	<u>MOBILE DEVICES MONITORING Function</u>	21
3.4.2	<u>BASE STATIONS MONITORING Function</u>	22
3.4.3	<u>USER LIST Function</u>	23
3.4.4	<u>ANALYZING DETECTED SIGNALS Function</u>	23
4	<u>INFRARED DETECTOR Channel</u>	26
4.1	<u>DIFFERENTIAL Mode</u>	27
5	<u>CONNECTING ST 500 TO WIRE LINES</u>	28
5.1	<u>Connecting to Electric Mains</u>	28
5.2	<u>Connecting to LAN</u>	28
5.3	<u>Connecting to Telephone Lines</u>	29
5.4	<u>Connecting to Low Current Multi-Core Cables without Connectors</u>	30
6	<u>WIRED RECEIVER Channel (WR)</u>	31
6.1	<u>Circuit Type Selection</u>	31
6.2	<u>Frequency Range Selection</u>	31
	<u>ELECTRIC MAINS TESTING</u>	
6.3	<u>PANORAMA Mode (Electric Mains Testing)</u>	32
6.4	<u>DIFFERENTIAL Mode</u>	34
6.4.1	<u>FIXED FREQUENCY ANALYSIS Function</u>	35
6.4.2	<u>OSCILLOSCOPE Function</u>	36
6.5	<u>AUTOMATED Mode</u>	37
6.5.1	<u>FREQUENCY TUNING Function</u>	38
6.5.2	<u>OSCILLOSCOPE Function</u>	38
	<u>LOW CURRENT CIRCUIT TESTING</u>	
6.6	<u>ELECTRONIC SWITCH CONTROL Mode</u>	39
6.7	<u>ELECTRONIC SWITCH SETTINGS Mode</u>	41
6.8	<u>PANORAMA Mode (Low Current Circuit Testing)</u>	42

7	<u>LOW FREQUENCY AMPLIFIER Channel (LFA)</u>	44
7.1	<u>ELECTRONIC SWITCH CONTROL Mode</u>	44
7.2	<u>ELECTRONIC SWITCH SETTINGS Mode</u>	46
7.3	<u>Setting the Gain</u>	46
7.4	<u>Setting the Bias Voltage</u>	47
7.5	<u>AUTOMATED Mode</u>	48
7.6	<u>OSCILLOSCOPE</u>	48
7.7	<u>SPECTRUM ANALYZER</u>	49
8	<u>ST 500 SOFTWARE</u>	51
8.1	<u>Purpose</u>	51
8.2	<u>Functionality</u>	51
8.3	<u>PC Requirements</u>	51
8.4	<u>Installation</u>	51
8.5	<u>Graphical Interface</u>	52
8.6	<u>Operation Modes</u>	52
8.6.1	<u>RANGES HIGHLIGHTING Mode</u>	53
8.6.2	<u>MOBILE BANDS Mode</u>	55
8.6.3	<u>BASE BANDS Mode</u>	58
8.6.4	<u>USER BANDS Mode</u>	58
8.6.5	<u>FIRMWARE UPDATE Mode</u>	58
	USE GUIDELINES	
9	<u>USE GUIDELINES</u>	60
9.1	<u>Guidelines for Use of SELECTIVE HF DETECTOR Channel</u>	60
9.1.1	<u>Search in the AUTOMATED Mode</u>	60
9.1.2	<u>Search in the PANORAMA Mode and DIFFERENTIAL Mode</u>	61
9.1.3	<u>Search in the WIRELESS COMMUNICATION Mode</u>	62
9.1.4	<u>Localization of the Source of Detected Signal</u>	63
9.2	<u>Guidelines for Use of INFRARED DETECTOR Channel</u>	64
9.2.1	<u>Selection of "False" Signals</u>	64
9.3	<u>Guidelines for Use of the WIRED RECEIVER Channel</u>	65
9.3.1	<u>Electric Mains Testing</u>	65
9.3.2	<u>Low Current Circuit Testing</u>	67
9.4	<u>Guidelines for Use of LOW FREQUENCY AMPLIFIER Channel</u>	68
9.4.1	<u>Search for Active Microphones in an Analog Telephone Line</u>	69
9.4.2	<u>Activation of Electret Microphones in an Analog Telephone Line</u>	70
9.5	<u>Localization of the Signal Source Detected by the "WR" or "LFA" Channels</u>	70
9.5.1	<u>Acoustic Method</u>	70
9.5.2	<u>Localization with ST 500 and Non-Linear Junction Detector</u>	71
	SUPPLEMENTS	
10	<u>Supplement #1. Functions of the Controls</u>	72
10.1	<u>Basic Settings</u>	72
10.2	<u>SELECTIVE HF DETECTOR</u>	73
10.3	<u>IR DETECTOR</u>	76
10.4	<u>WIRED RECEIVER</u>	76
10.5	<u>LOW FREQUENCY AMPLIFIER</u>	80
11	<u>Supplement #2. Typical Settings of the Electronic Switch</u>	82
12	<u>Supplement #3. Reference Information</u>	84
12.1	<u>"Twisted Pair" Cable</u>	84
12.2	<u>RJ Connectors</u>	84
12.3	<u>Wiring Scheme of a Four Twisted Pair Cable</u>	84
12.3.1	<u>Wiring Scheme EIA/TIA-568A</u>	86
12.3.2	<u>Wiring Scheme EIA/TIA-568B</u>	85
12.4	<u>Crossover Wiring Scheme</u>	85
12.5	<u>Wiring Scheme of a Three, Two, and One Pair Twisted Cable</u>	86
12.6	<u>Reference Information on Telephone Lines</u>	86

1. GENERAL INFORMATION

This user manual describes the composition and operation of the multifunctional detection device ST 500 "PIRANHA" The information contained in this manual is cross-referenced with hyperlinks.

1.1. PURPOSE AND CAPABILITIES

The multifunctional detection device ST 500 "PIRANHA" is intended for the detection and location of eavesdropping devices.

Functionally, the device consists of four detection channels.

Channels for the detection of wireless eavesdropping devices:

- **SELECTIVE HF DETECTOR** is intended for the detection of analog and digital wireless (utilizing GSM, LTE, Bluetooth, or Wi-Fi) eavesdropping devices operating in the frequency range 20 - 6000 MHz.
- **IR DETECTOR** is intended for the detection of IR transmitters (eavesdropping devices using the infrared range for transmissions).

Channels for the detection of wired eavesdropping devices:

- **WIRED RECEIVER** is intended for the detection of high-frequency signals from eavesdropping devices that transmit information via electric mains and low current lines in the frequency range 100 kHz – 180 MHz.
- **LOW FREQUENCY AMPLIFIER** is intended for the detection of LF signals from eavesdropping devices.

Each CHANNEL works in certain MODES
Each MODE corresponds to a set of search FUNCTIONS

FUNCTIONALITY OF THE DEVICE:

1. Detection and location of radio eavesdropping devices:
 - radio microphones, telephone radio repeaters, radio stethoscopes, etc.
 - video cameras with radio transmitters
 - radio beacons of tracking systems.
2. Identification of digital protocols of the detected radio signals: GSM, CDMA, Bluetooth, LTE, Wi-Fi.
3. Identification of signals of base stations and mobile digital communication devices.
4. Detection and location of active wired eavesdropping devices:
 - wired microphones transmitting through permanent and makeshift low current lines
 - detection of signals from eavesdropping devices transmitting over electric mains and low current lines in the frequency range from 0.1 - 180 MHz.
5. Activation of wired electret microphones by applying a bias voltage to the circuit
6. Detection and location of eavesdropping devices that utilize infrared transmissions.

1.2. SPECIFICATION

1.	Main Unit.....	1 pcs.
2.	Adapter for connecting the main unit to electric mains.....	1 pcs.
3.	Cable for connecting the main unit to telephone line sockets.....	1 pcs.
4.	Cable for connecting the main unit to low current sockets.....	1 pcs.
5.	Cable for connecting the main unit to a PC's USB	1 pcs.
6.	Telescopic antenna.....	1 pcs.
7.	Charger.....	1 pcs.
8.	Headphones.....	1 pcs.
9.	USB flash drive.....	1 pcs.
10.	Coupler (RJ11).....	1 pcs.
11.	Coupler (RJ45).....	1 pcs.
12.	1x2 splitter (RJ11).....	1 pcs.
13.	1x2 splitter (RJ45).....	1 pcs.
14.	Adapter for connecting a multicore cable and screwdriver.....	1 pcs.
15.	Case.....	1 pcs.

The numbers above correspond to those in fig.1.



Fig.1

For transportation and storage of the device, the shock- and moisture-proof plastic case is used. All the items in the bundle are housed in the two panels within the case.



In the placement scheme above, the numbers assigned to items in the ST 500 bundle are the same as in 1.2.1.

1.3. DESCRIPTION OF SPECIFICATION ITEMS

1.3.1. MAIN UNIT WITH ELECTRONIC SWITCH

Main unit functions:

- analysis of the incoming signals,
- control of connection schemes to the tested multiwire lines,
- data display,
- control of operation modes.

Components of the main unit:

- signal processing module,
- electronic switch,
- display module,
- power supply module,
- controls.

The appearance of the main unit is shown in fig.2.

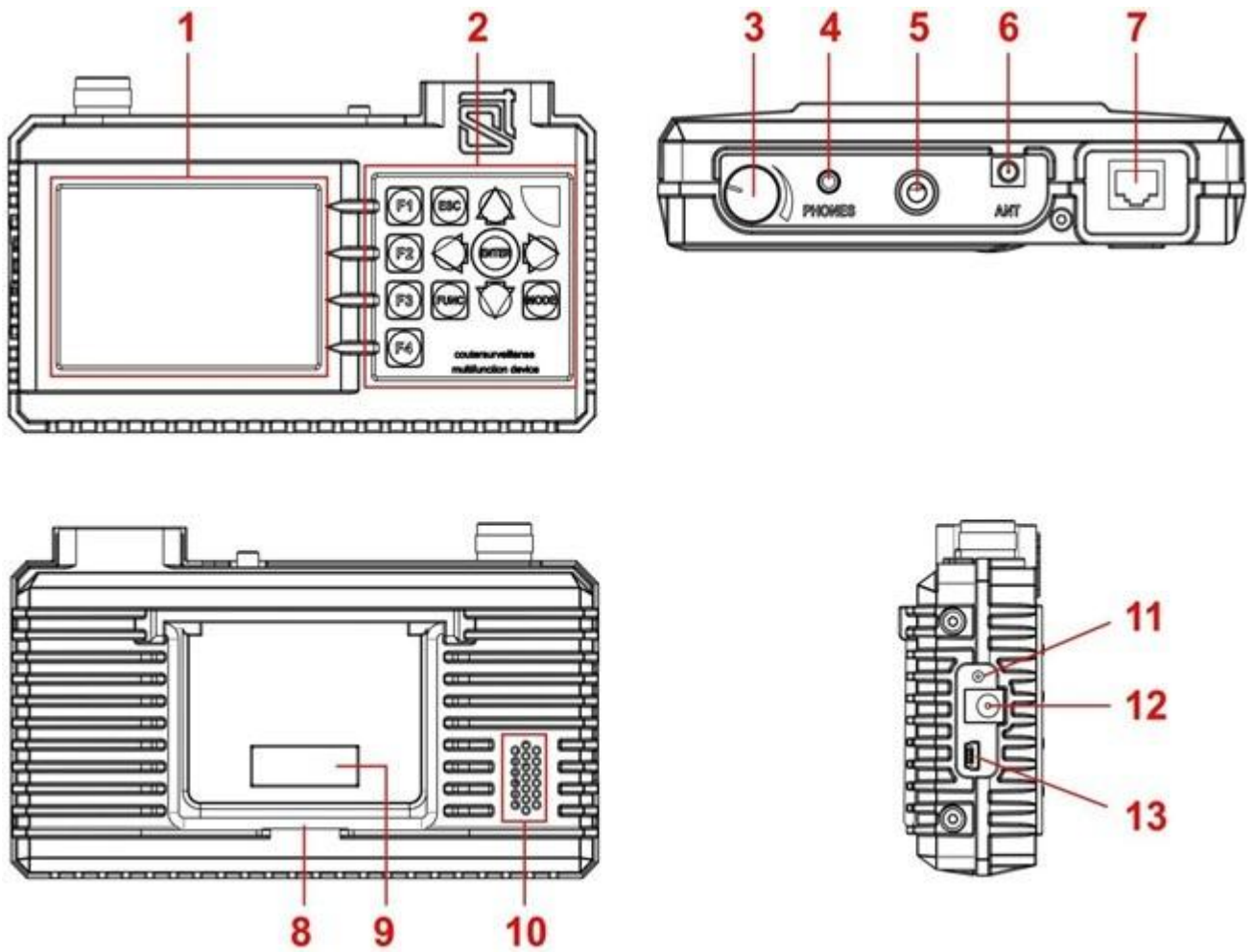

Fig.2

Number in fig.2	Marking on the device	Element description
1		Display
2		Keyboard
	F1-F4	Hotkeys
	ESC	Cancellation (return) key
	FUNC	Key to enable additional functions
	ENTER	Confirmation key
	MODE	Main menu key
3		Power switch and volume control
4	PHONES	Headphone socket

Number in fig.2	Marking on the device	Element description
5		Sensor of the IR DETECTOR
6	ANT	Antenna socket of the SELECTIVE HF DETECTOR
7	INPUT	Electronic switch input
8		Prop
9		Info shield with serial number
10		Inbuilt speaker
11		Charger connected indicator
12		Charger socket
13		Mini-USB for PC connection

1.3.2. ELECTRONIC SWITCH

The device is equipped with an inbuilt electronic switch for a more efficient testing of multiwire cables.

The automated and manual control of the electronic switch allow engaging all possible paired combinations of cores in a multicore cable connected to the electronic switch (via RJ45 socket, [fig.2, 7](#)). While testing electric mains, control of the electronic switch is disabled.

1.3.3. ADAPTER FOR CONNECTING TO ELECTRIC MAINS

The adapter is intended for connecting the main unit to electric mains equipped with European standard sockets ([fig.1, 2](#)). A LED indicator in the plug shows if the line is powered. The adapter cable is equipped with an RJ45 connector, with only the first and second pins are engaged, and the rest are disabled.

1.3.4. CABLE FOR CONNECTING TO COMPUTER SOCKETS (RJ45)

The cable is used for connecting the main unit to a computer line equipped with standard RJ45 connectors.

The cable ([fig.1, 4](#)) is a standard patch cord.

1.3.5. CABLE FOR CONNECTING TO TELEPHONE SOCKETS (RJ11)

The cable is used for testing telephone lines equipped with 6P4C sockets. The cable ([fig.1, 3](#)) is equipped with 8P8C (RJ45) and 6P4C connectors. In the RJ45 connector, the four central pins (## 3-6) are engaged, while the four side ones (## 1, 2, 7, 8) have no connections.

1.3.6. ADAPTER FOR CONNECTING A MULTICORE CABLE

The adapter ([fig.1, 12](#)) is used for connecting to raw-ended (not fitted with connectors) low current cables. While connecting a raw-ended twisted pair cable, it is advised to observe the wiring color scheme ([Supplement #3, 12.3.2](#)).

1.3.7. MINI-USB CABLE

The cable ([fig.1, 5](#)) is used for connecting the main unit to a PC's USB-port.

1.3.8. SPLITTERS, ADAPTERS, AND CONNECTOR CABLES

A set of splitters and connecting cables is supplied with ST 500, that are used for testing various types of cabling and circuits. Their use is described in Section 5 of this manual:

CONNECTING ST 500 TO CABLING

1.3.9. USB FLASH DRIVE

The USB flash drive contains pre-recorded test sounds for the test sound source, this Manual, and "ST 500" software.

1.3.10. TEST SOUND SOURCE (not included in the package)

A test sound source is required to search for eavesdropping devices. Any portable device equipped with a speaker (smartphone, tablet, voice recorder) can be used.

Purpose of the test sound source:

- creation of an acoustic signal (the correlation of this signal and the information obtained using the ST 500 means that there is an active eavesdropping device with an unencrypted transmission channel in the room);
- forced inclusion of eavesdropping devices equipped with a VOX activation system;
- localization of detected listening devices;
- creation of the "masking noise" during the search operations.

Files with sounds are recorded on a USB drive ([fig.1, 9](#)). The user can use their own sound files that are optimally suited to the situation in which the search event is held (noise in the office, people talking, music, etc.).

1.4. POWER SUPPLY

The device is only powered from an inbuilt battery whose charge status is shown in the status bar ([fig.5, 2](#)). A fully charged battery provides 7 hours of non-stop operation.

The battery is charged with the aid of a charger unit ([fig.1, 7](#)) plugged into the socket on the side of the Device ([fig.2, 12](#)). The charger is connectable to 220 V/50 Hz mains.

During charging a LED on the side of the Device ([fig.2, 11](#)) will be lit red. Full charging time is up to 7 hours. Upon charging, the LED will change its light to green.

DO NOT ATEMPT CHARGING THE DEVICE DURING OPERATION!

1.5. TECHNICAL SPECIFICATIONS

Selective HF Detector:	
operative frequency range, MHz	20-6000
passband, MHz	1 or 20
impedance, Ohm	50
rate of scanning, GHz/sec	18
bandpass flatness, dB	±6
minimum detection level, dB	-70
dynamic range, dB	50
IR Detector:	
spectral range, μm	0.75...1.1
detection passband, MHz	5
field-of-view angle, degrees	±20
minimum detectable power, W/Hz ^{1/2}	10 ⁻¹³
Wired Receiver:	
operative frequency range, MHz	0.1-180
whole range scanning time, sec	2
minimum detection level, dBm	-50...-75
dynamic range, dB	50
impedance, Ohm	100
demodulation type	AM, FM
input filter passband, kHz	180
maximum voltage on the circuit, V	250(AC), 60(DC)
Low Frequency Amplifier:	
frequency range, Hz	20 - 25000
impedance, kOhm	200
gain, times	1,2,5,10,20,50,100
max voltage amplitude on the input, V	±60(DC), ±1(AC)
noise spectral density, nV/Hz	3
bias voltage range, V	+30, -30
Power Supply:	
inbuilt lithium polymer accumulator battery with voltage, V	3.7
power consumption, W	<1
time of continuous operation at maximum power, hrs	>4
recharging time from a full discharge, hrs	7
Weight and Dimensions:	
dimensions of the main unit (length, width, height), mm	165 x 100 x 40
mass of the main unit, kg	0.470
case dimensions (length, width, height), mm	360 x 255 x 195
full package mass (with case), kg	4,5

2. INTERFACE OPTIONS

2.1. TURNING THE DEVICE ON/OFF

The Device is turned on/off with the power switch and volume control button (fig. 2, 3). When turned on, the display will show a screen (fig.3) logo, name of the Device, and firmware version number.



Fig.3



Press any key to go to the main menu of device.

2.2. MAIN MENU

One of the four operation channels, or the service mode "SETTINGS", can be selected from the main menu. The main menu screen is shown in fig.4.



Fig.4

To activate channels "SELECTIVE HF DETECTOR", "IR DETECTOR", "LOW FREQUENCY AMPLIFIER", and "WIRED RECEIVER", with the keys  and  move the cursor to the corresponding line and press "ENTER", or use the hotkeys ("F1", "F2", "F3", "F4", respectively).

Through the "SETTINGS" menu item, system settings can be accessed.

2.3. STATUS BAR

In the upper part of the Device's screen is a status bar shown in fig.5



Fig.5

In fig.5:

- 1 - active channel
- 2 - electric mains sign
- 3 - pair of wires connected
- 4 - battery charge sign
- 5 - current time (hh:mm)

2.4. "SETTINGS" SERVICE MODE

This SETTINGS mode is intended for setting the date, time and interface language ().

To enter the settings mode, using the keys  and  select "SETTINGS" in the main menu and press "ENTER".

To exit SETTINGS mode to the main menu, press "ESC". Any confirmed changes will be saved upon exiting this mode or deactivating the device. The "SETTINGS" screen is shown in fig.6.

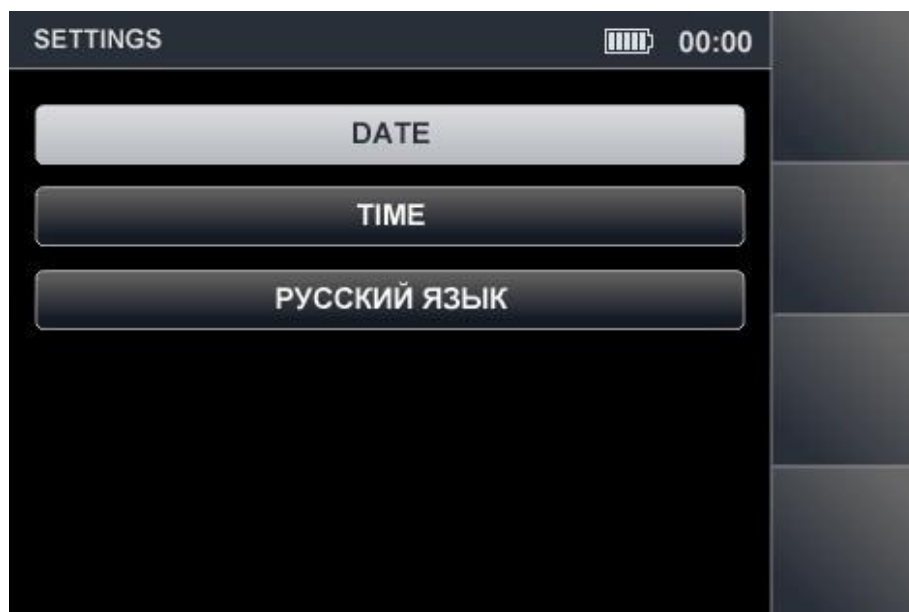

Fig.6

2.4.1. SETTING THE DATE







In order to set the date, use the keys  and  to select "DATE" in the menu and press "ENTER". The following screen (fig.7) will appear.



Fig.7

The date format is "DD/MM/ YYYY". Use the keys  and  to select "DAY", then use  and  to set the desired value. Proceed in the same way to set "MONTH" and "YEAR". Use "ENTER" to confirm changes. Use "ESC" to go back to "SETTINGS". To exit the SETTINGS mode without saving changes, press "ESC".

2.4.2. SETTING THE TIME



In order to set the time, use  or  to select "TIME" in the "SETTINGS" menu and press "ENTER". The following screen (fig.8) will appear, with time in the format "HH/MM".



Fig.8

The time can be set in the same way as the date (3.4.1). Use the "ENTER" to confirm changes. Use "ESC" to go back to "SETTINGS". To exit the SETTINGS mode without saving changes, press "ESC".

2.4.3. SETTING THE LANGUAGE

In order to set the interface language, using  or  select "LANGUAGE" in the menu and press "ENTER". The interface language will be changed.

3. "SELECTIVE HF DETECTOR" CHANNEL

The "SELECTIVE HF DETECTOR" channel is intended for the detection of analog and digital wireless (utilizing GSM, LTE, Bluetooth, or Wi-Fi) eavesdropping devices operating in the frequency range 20 MHz - 6 GHz.

For the reception of radio signals, a telescopic antenna is used (fig.1, 6) that has a spherical radiation pattern. The antenna is connected to a socket on the upper surface of the device (fig.2, 6).

The channel is activated from the main menu.

The detected signals are analyzed based on:

- graphic information (spectrogram, oscillogram, table of signals)
- acoustic information (via headphones or inbuilt speaker).

Functional Scheme of the "SELECTIVE HF DETECTOR" Channel

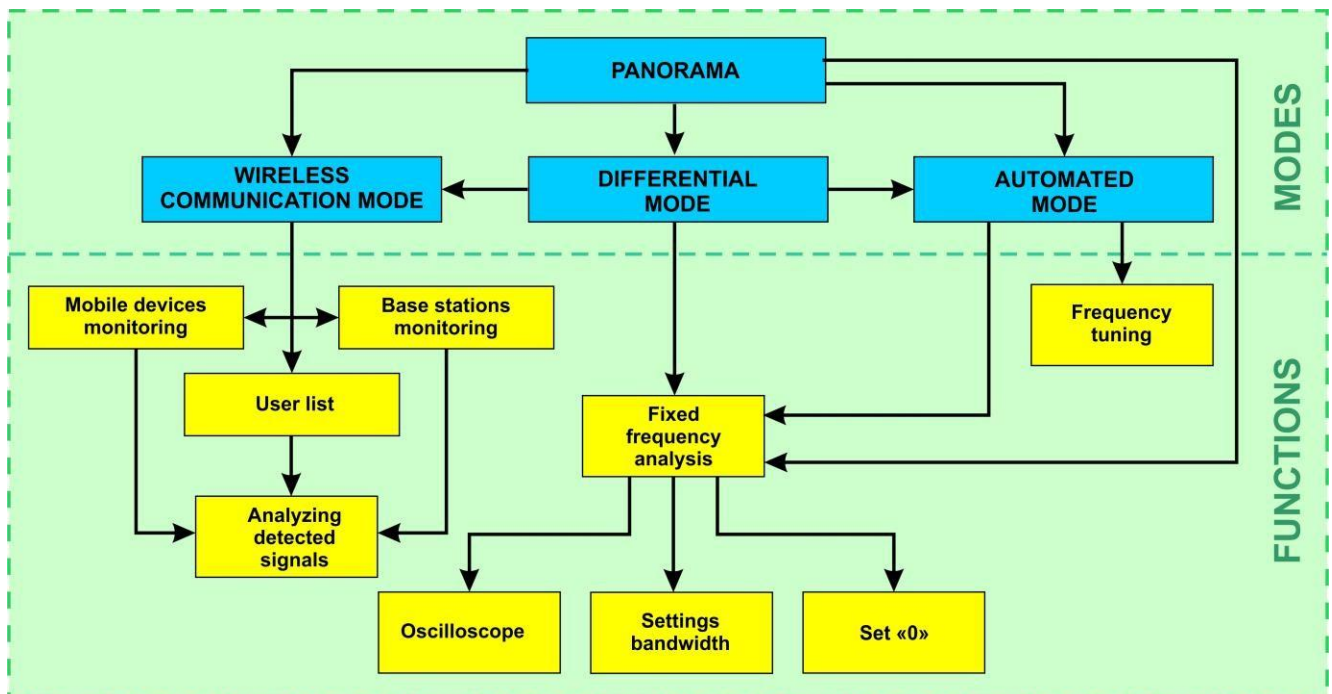

3.1. "PANORAMA" MODE

The "PANORAMA" mode is started by default when the "SELECTIVE HF DETECTOR" channel is activated. All activity in the frequency band will be shown on the screen (fig. 9).

Functionality:

- activating the AUTOMATED mode
- activating the "WIRELESS COMMUNICATION" mode
- activating the DIFFERENTIAL mode
- analyzing the signal at a fixed frequency
- setting the gain
- adjusting the band limits

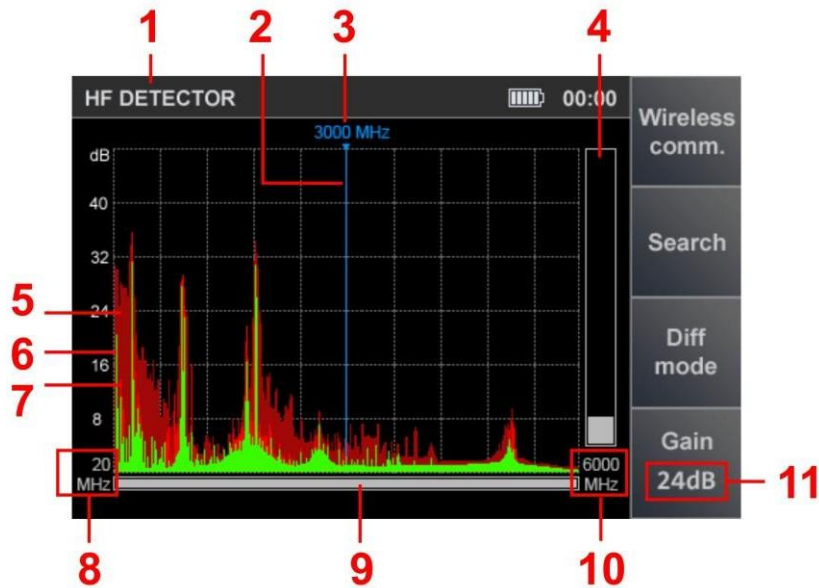



Fig.9





In fig.9:

- 1 - active channel
- 2 - screen cursor
- 3 - frequency value at the current cursor position
- 4 - dynamic bar indicating signal level at the selected frequency
- 5 - peak signal value over all cycles at the selected frequency (maroon)
- 6 - pulse signals detected in the last measurement cycle (green)
- 7 - continuous signals detected in the last measurement cycle (red)
- 8 - lower bound of the set frequency range viewing band
- 9 - indicator showing the width of the set viewing bar relative to the maximum possible
- 10 - upper bound of the set frequency range viewing band
- 11 - gain value

Controls:

Key	Action
ESC, MODE	switching to main menu of device
ENTER	turn on "FIXED FREQUENCY ANALYSIS" function
	screen cursor positioning
	panorama scaling relative to frequency on the marker
F1	activating "WIRELESS COMMUNICATION" mode
F2	activating AUTOMATED mode
F3	activating DIFFERENTIAL mode
F4	gain setting on/off
FUNC	disabled

GAIN SETTING:

1. Press "F4". The "Gain" field will become lighter.
2. Use the keys     to set the gain in dB (0, 8, 16, 24, 32, 40). The gain value will be shown in the corresponding screen field (fig.10).
3. Press "F4". The "Gain" field will become darker.

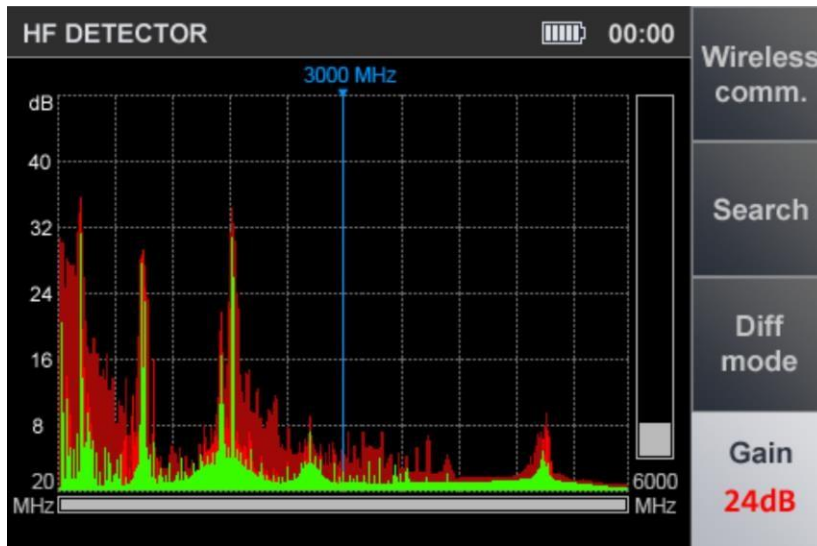

Fig.10

IMPORTANT! Until the gain setting is completed, other modes and functions are not available, except for switching to the Main Menu of the device (by pressing "MODE").

3.2. DIFFERENTIAL MODE

In the DIFFERENTIAL mode, signal levels registered during previous scanning cycles in the "PANORAMA" mode, are set as "0", and only signals in excess of "0" will be shown on the screen (differential spectrum).

The DIFFERENTIAL mode can be used for isolating the signals from sources within the inspected premises, from external signals.

The DIFFERENTIAL mode can be activated from the "PANORAMA" mode (fig.9) by pressing "F3". The "F3" key field will become highlighted.

Upon activating the DIFFERENTIAL mode, the screen will look as shown in fig.11.

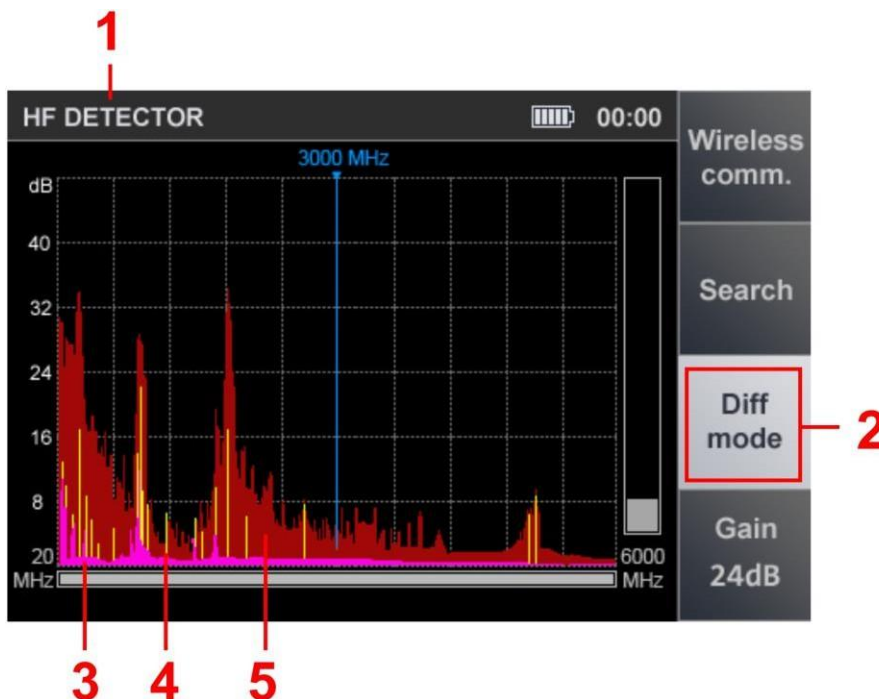

Fig.11

In fig.11:



- 1 - active channel
- 2 - DIFFERENTIAL mode highlighted as currently active
- 3 - constant differential signal registered during the last scanning cycle (lilac)
- 4 - pulse differential signal registered during the last scanning cycle (yellow)
- 5 - peak signal level at the given frequency over all cycles (maroon)

Functionality:

- activating the AUTOMATED mode
- activating the "WIRELESS COMMUNICATION" mode
- analyzing the signal at a set frequency
- setting the gain
- adjusting the band limits (zoom)

Switching off the DIFFERENTIAL mode (return to the "PANORAMA" mode) is performed by pressing the "F3". The "F3" key field will become darker. Gain values and span set in DIFFERENTIAL mode are saved.

3.2.1. "FIXED FREQUENCY ANALYSIS" FUNCTION

This feature is intended for researching signals detected in the "PANORAMA" or DIFFERENTIAL mode. To activate it from either of said modes, select the signal of interest using  and  and press "ENTER". The screen will look as shown in fig.12 below.

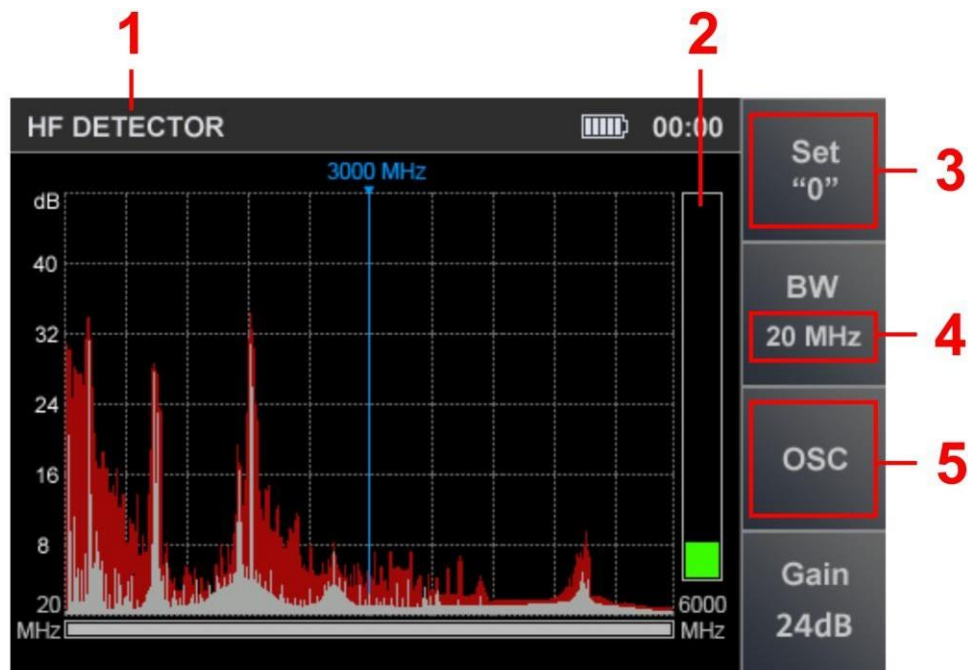
**Fig.12**



In fig.12:

- 1 - active detection channel
- 2 - signal level at the selected frequency (at cursor position)
- 3 - "SET "0" active
- 4 - selected passband (1 MHz or 20 MHz)
- 5 - OSCILLOSCOPE active

Functionality:

- tuning to the frequency of the detected signal
- passband selection (1 MHz or 20 MHz);
- listening to a demodulated signal
- analyzing the signal with oscilloscope
- locating the signal source with power method

Controls:

Key	Action
MODE	switching to the main menu of device
ENTER, ESC	turning off "FIXED FREQUENCY ANALYSIS" function
	screen cursor positioning
F1	turning on/off "SET "0" function
F2	passband selection (1 MHz or 20 MHz)
F3	turning on OSCILLOSCOPE
F4	turning on/off gain setting
FUNC 	disabled

To turn off "FIXED FREQUENCY ANALYSIS" function, press "ENTER" or "ESC". The device will switch back to the mode, from which the function was activated ("PANORAMA" or DIFFERENTIAL mode).

3.2.2. "SET "0" FUNCTION

This function helps locate the source of a detected signal. It can be especially helpful in finding the sources of powerful signals that make the screen levels go off-scale even at minimum gain. Ways of locating eavesdropping devices are described in more detail in [9.1.4.](#)

When "SET "0" is used, the signal level at current frequency is set as "0", and only the level differences are displayed.

To turn on the "SET "0", press "F1". The "F1" key field will become lighter.

When using the "SET "0" function, it is possible to:

- change the passband ("F2")
- turn on the oscilloscope ("F3")
- change the gain ("F4")

To turn off the "SET "0", press "F1" again. The "F1" field will become darker.

3.2.3. OSCILLOSCOPE

To activate the OSCILLOSCOPE, after switching on the "FIXED FREQUENCY ANALYSIS" function, press the "F3". The "OSC" field will become lighter. The screen will look as shown in fig.13 below.

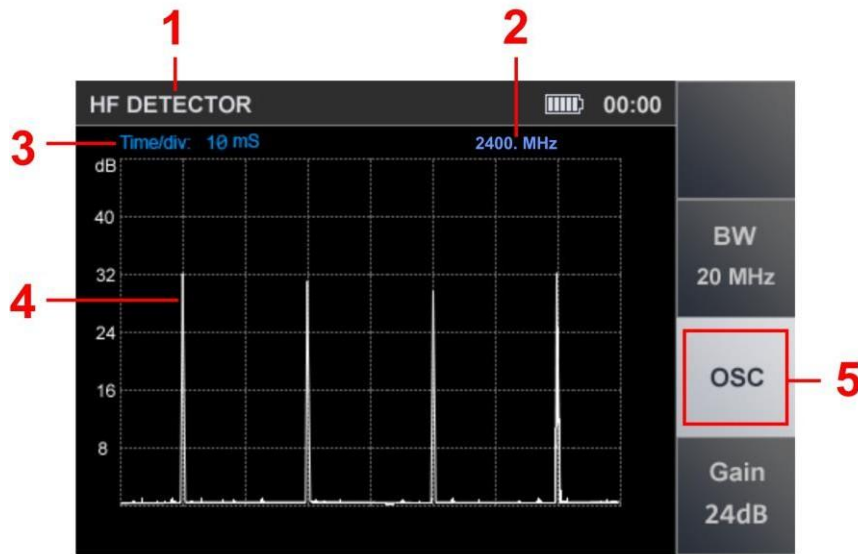

Fig.13

In fig.13:

- 1 - active detection channel
- 2 - selected frequency value
- 3 - set division value of the time axis
- 4 - oscillogram of a demodulated signal at the selected frequency
- 5 - on indication of the inclusion of the OSCILLOSCOPE

Functionality:

- determining the time parameters of a demodulated signal
- setting the division value of the time axis
- passband selection
- gain adjustment

Controls:

Key	Action
	selecting the division value of the horizontal sweep 100µS/200µS/500µS/1mS/2mS/5mS/10mS
F2	passband selection (1 MHz or 20 MHz)
F3, ESC	turning off OSCILLOSCOPE
F4	activating gain adjustment
MODE	switching to main menu of device
FUNC ENTER F1	disabled

To turn off the OSCILLOSCOPE press "F3" or "ESC".

3.3. AUTOMATED MODE

The AUTOMATED mode is used to register signals whose amplitudes exceed the adaptive detection threshold. It is activated from the DIFFERENTIAL or "PANORAMA" mode by pressing "F2".

Search for signals is performed within set frequency limits, based on the data obtained in the DIFFERENTIAL mode (if the AUTOMATED mode has been activated from the DIFFERENTIAL mode).

Each detected signal is assigned one of the three categories, "NON-THREAT", "THREAT", or "UNKNOWN". By default, those are:

"NON-THREAT" – signals of base stations of mobile telecommunication networks

"THREAT" – signals of mobile digital communication devices

"UNKNOWN" – all the remaining signals.

With the help of [ST 500 software \(8.6.1\)](#), bands can be assigned "THREAT" or "NON-THREAT" status, so that the received signals will be accordingly marked with color, depending on the frequency band they are in. Upon mode activation, the screen will look as shown in fig.14.

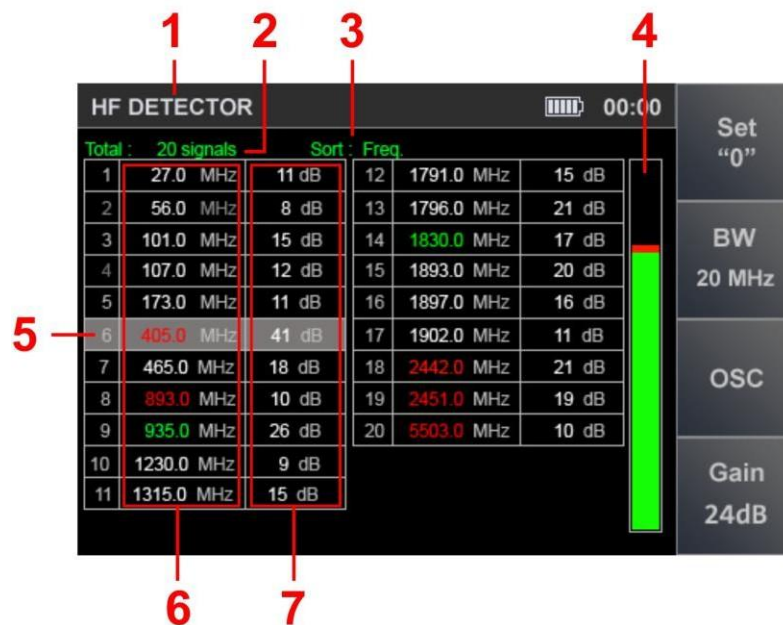

Fig.14

In fig.14:

- 1 - active channel
- 2 - number of the detected signals
- 3 - data sorting type (by level or frequency)
- 4 - signal level at the current cursor position
- 5 - current table row
- 6 - frequency values of the detected signals
- 7 - levels of the detected signals

In fig.14 frequency values of the detected signals are marked with different colors:

"THREAT" signals - red

"NON-THREAT" signals - green

"UNKNOWN" signals - white

Functionality:

- sorting the detected signals (by frequency or by level)
- quick tuning to the detected signal by selecting it in the table
- fine frequency tuning
- passband selection (1 MHz or 20 MHz)
- activating/turning off "SET "0"
- gain adjustment
- OSCILLOSCOPE activation

Controls:

Key	Action
	screen cursor positioning
FUNC	signal sorting
F1	turning on/off "SET "0" function
F2	passband selection (1 MHz or 20 MHz)
F3	turning on OSCILLOSCOPE
F4	activating gain adjustment
ENTER	turning on "FREQUENCY TUNING" function
ESC	returning to "PANORAMA" or DIFFERENTIAL mode
MODE	switching to main menu of device

3.3.2. "FREQUENCY TUNING" FUNCTION

For fine frequency tuning, select the corresponding table row and press "ENTER". The screen will look as shown in fig.15 below.

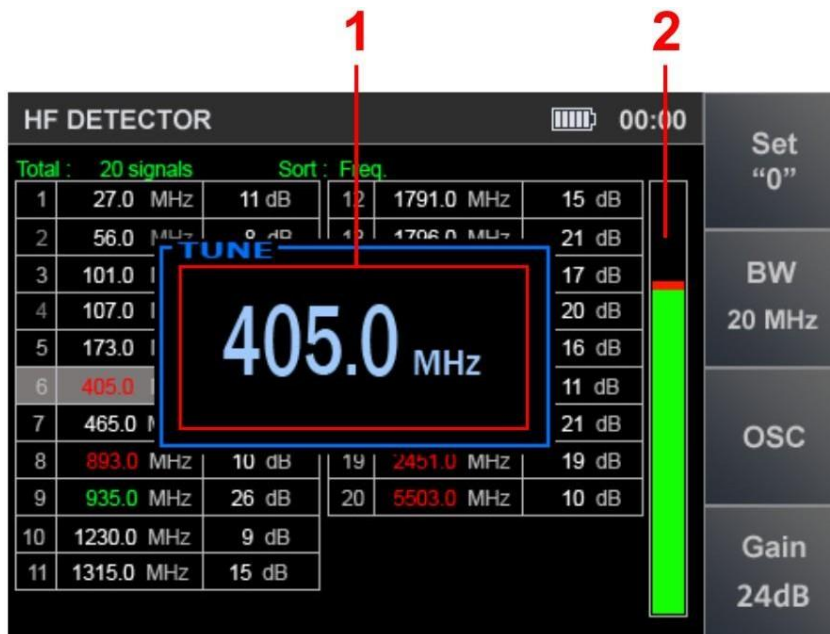
**Fig.15**

A frequency tuning window will appear on the screen (fig.15, 1). Using keys  set the frequency value at the maximum signal level (fig. 15, 2). The increment is 0.2 MHz. When finished, press "ENTER" or "ESC".

3.3.3. OSCILLOSCOPE

To analyze the demodulated signal with the oscilloscope, use the keys \leftarrow \rightarrow to select the corresponding table row and press "F3". Functionality and controls described in [3.2.3](#).

To turn off the OSCILLOSCOPE, press "F3" or "ESC".

3.4. "WIRELESS COMMUNICATION" MODE

The "WIRELESS COMMUNICATION" mode is intended for the detection of signals of the common digital communication standards.

ST 500 makes it possible to monitor operative frequency bands of mobile communication devices separately from those of base stations (if such division is specific to the communications standard). The operative frequency bands of mobile communications systems are set by default. The constitution and parameters of these bands can be adjusted using [ST 500 software](#).

The "USER LIST" function allows monitoring pre-defined frequency bands that are the most likely to be utilized by radio eavesdropping devices. The number of these bands, as well as their boundaries, are also set with the aid of ST 500 software.

The "WIRELESS COMMUNICATION" mode is activated from the "PANORAMA" or DIFFERENTIAL mode by pressing "F1". The "MOBILE DEVICES MONITORING" function is launched automatically.

3.4.1. "MOBILE DEVICES MONITORING" FUNCTION

This function helps detect active mobile digital communications devices and analyze their signals in the corresponding frequency range. The screen is shown in fig.16.

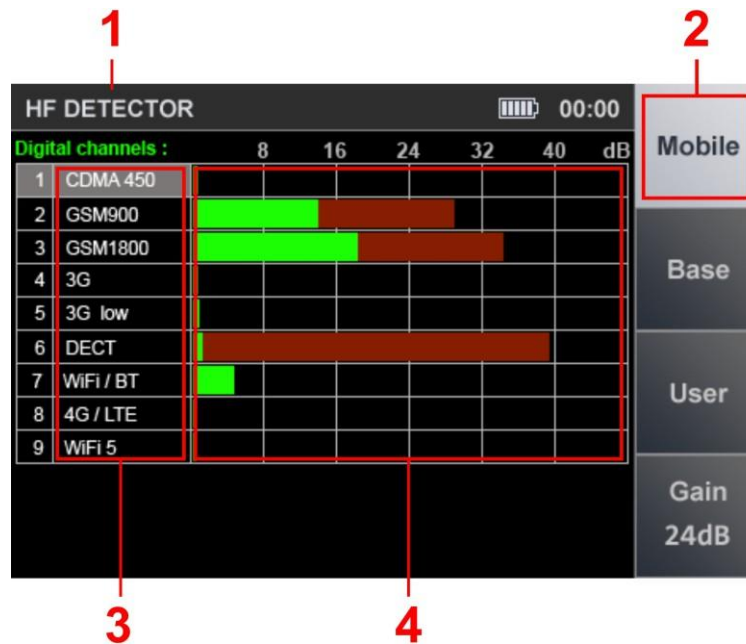



Fig.16

In fig.16:

- 1 - active channel
- 2 - active option (highlighted)
- 3 - list of digital communication standards
- 4 - signal levels (green for current level; maroon for peak signal level within the range over the whole monitoring period)

Controls:

Key	Action
	table row selection
ENTER	turning on "ANALYZING DETECTED SIGNALS" function
F2	turning on "BASE STATIONS MONITORING" function
F3	turning on "USER LIST" function
F4	activating gain adjustment
ESC	returning to "PANORAMA" or DIFFERENTIAL mode (to the previous mode)
MODE	switching to the main menu of device
F1, FUNC 	disabled

3.4.2. "BASE STATIONS MONITORING" FUNCTION

This allows identifying and analyzing the signals from base stations of mobile communications networks in real time. The screen looks as shown in fig.17.

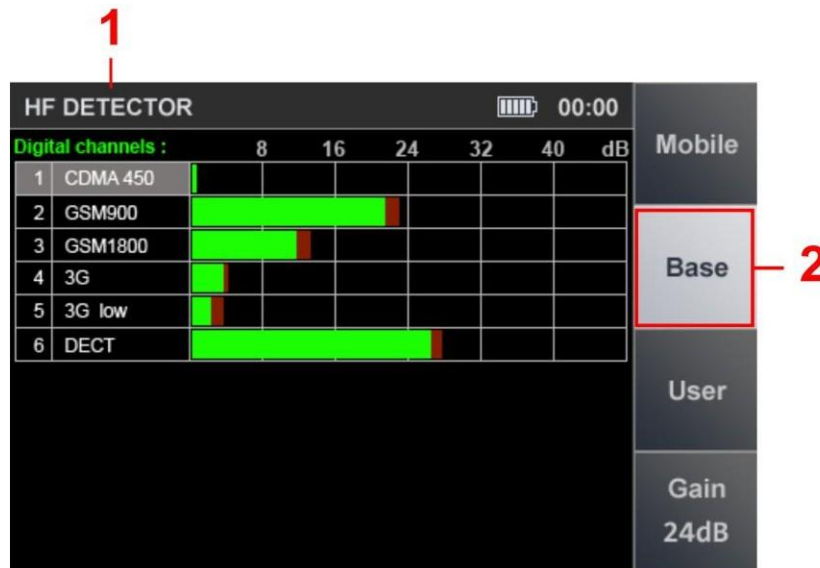
**Fig.17****In fig.17:**

- 1 - active channel
- 2 - active option (highlighted)

Controls:

Key	Action
	table row selection
ENTER	turning on "ANALYZING DETECTED SIGNALS" function
F1	turning on "MOBILE DEVICES MONITORING" function
F3	turning on "USER LIST MONITORING" function
F4	turning on gain adjustment
ESC	switching to "PANORAMA" or DIFFERENTIAL mode (to the previous mode)
MODE	switching to the main menu of device

3.4.3. "USER LIST" FUNCTION

This function allows detecting the activity of radio transmitters in pre-set frequency ranges, and analyze the detected signals.

The screen will look as shown in fig.18.

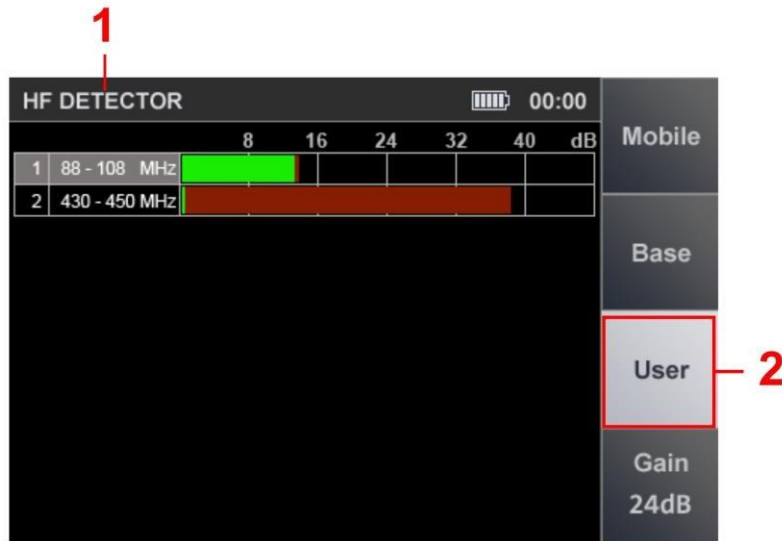

Fig.18

In fig.18:

- 1 - active channel
- 2 - active option (highlighted)

Controls:

Key	Action
⏴ ⏵	table row selection
ENTER	turning on "ANALYZING DETECTED SIGNALS" function
F1	turning on "MOBILE DEVICES MONITORING" function
F2	turning on "BASE STATIONS MONITORING" function
F4	turning on gain adjustment
ESC	switching to "PANORAMA" or to the DIFFERENTIAL mode (to the previous mode)
MODE	switching to the main menu of device

3.4.4. "ANALYZING DETECTED SIGNALS" FUNCTION

The "MOBILE DEVICES MONITORING", "BASE STATIONS MONITORING", and "USER LIST" functions make it possible to detect the presence of signals and estimate their levels; however, it is impossible to determine the number of signals in each range and establish their frequencies with absolute precision.

The "ANALYZING DETECTED SIGNALS" function is intended for a more precise study of the detected signal in a range. It allows determining signal frequencies (in standard bands) and analyzing them with OSCILLOSCOPE

It can be activated from any screen of the "WIRELESS COMMUNICATION" mode. To activate it, use the ⏴ ⏵ to select a table row with a detected signal, and press "ENTER".

Upon activation, the screen will look as shown in fig.19.

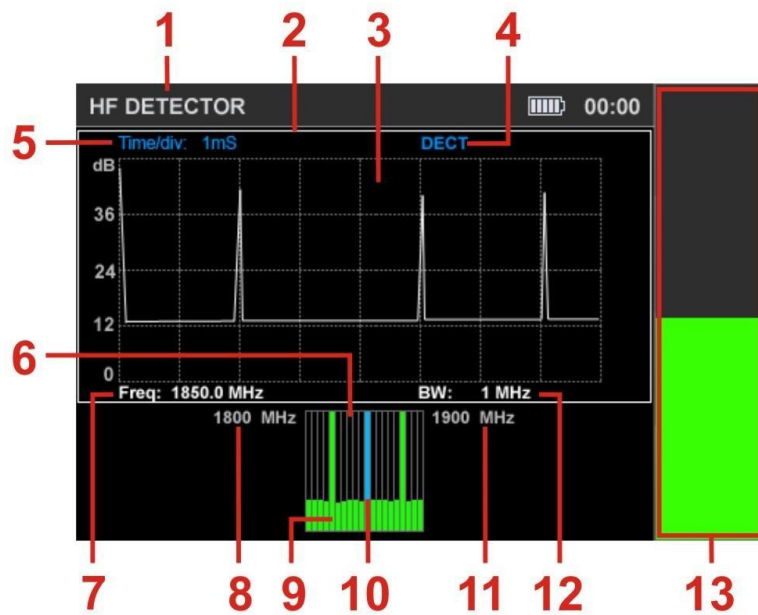



Fig.19

In fig.19:

- 1 - active channel
- 2 - white frame of the active window (OSCILLOSCOPE or SPECTRUM ANALYZER)
- 3 - OSCILLOSCOPE window
- 4 - digital communications standard
- 5 - division value of the oscilloscope time axis
- 6 - SPECTRUM ANALYZER window
- 7 - frequency value at SPECTRUM ANALYZER marker position
- 8 - lower bound of range
- 9 - spectrum
- 10 - SPECTRUM ANALYZER marker
- 11 - upper bound of range
- 12 - passband width
- 13 - signal level (at the current frequency)

The screen is divided into three windows:



- Signal level bar (fig.19, 13)
- OSCILLOSCOPE (fig.19, 3)
- SPECTRUM ANALYZER (fig.19, 6)

The signal level bar shows signal level at the current frequency (fig.19, 7) as determined by the position of the SPECTRUM ANALYZER marker (fig.19, 10). The oscillogram (fig.19, 3) and the spectrogram (fig.19, 6) are displayed in two other windows. Only one window can be active at a time, highlighted by a white frame (fig.19, 2). To switch between OSCILLOSCOPE and SPECTRUM ANALYZER windows, use the  and  keys.

For locating the source of the detected signal, the "SET "0" function is implemented. When activated, the detected signal level is set as "0" and the signal level bar will be showing the difference in excess of it (the level bar changes color to lilac).

To turn the "SET "0" function on/off, use "ENTER".

OSCILLOSCOPE and SPECTRUM ANALYZER controls

Key	Action
MODE	switching to the main menu of device
ESC	switching to the previous mode
ENTER	turning on/off SET "0" function
	horizontal zoom (OSCILLOSCOPE) cursor positioning (SPECTRUM ANALYZER)
	switching between OSCILLOSCOPE and SPECTRUM ANALYZER
F1 - F4, FUNC	disabled

4. "INFRARED DETECTOR" CHANNEL ("IR DETECTOR")

The "IR DETECTOR" channel is intended for the detection of eavesdropping devices that utilize the infrared range for transmissions.

The infrared detector sensor is located on the upper surface of the Device ([fig.2, 5](#)).

Analysis of the detected signals is carried out using:

- graphic information (oscillogram and signal level bar)
- acoustic information (headphones or built-in speaker).

The channel is activated from the main menu ([fig.4](#)). The screen will look as shown in [fig.20](#).

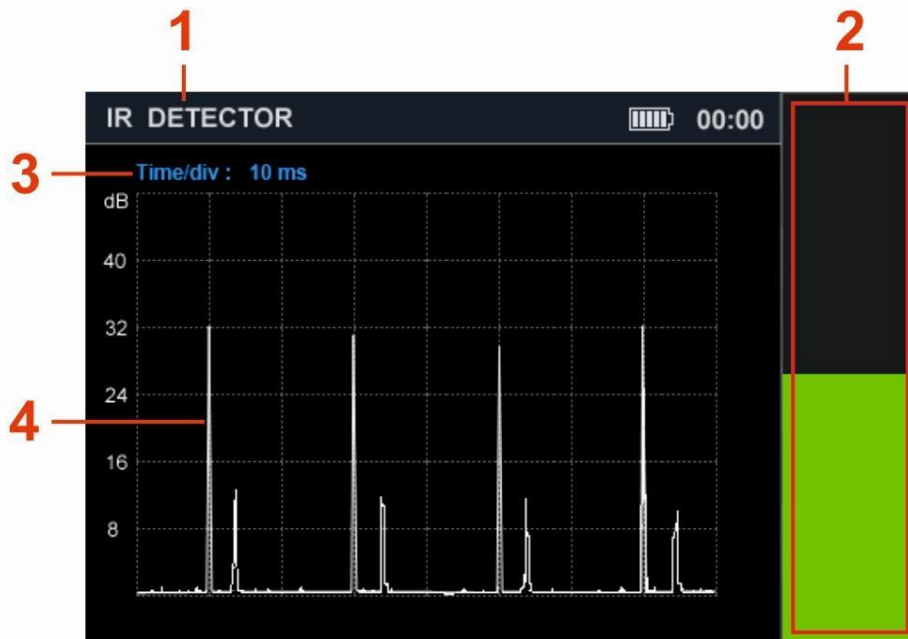

Fig.20

In fig.20:

- 1 – active channel
- 2 – signal level bar
- 3 – division value of the time axis
- 4 - oscillogram

Controls

Key	Action
ESC, MODE	switching to main menu
ENTER	turning on/off DIFFERENTIAL mode
↔	horizontal zoom of the oscilloscope
F1 - F4, FUNC ⏏ ⏪	disabled

4.1. DIFFERENTIAL MODE

The DIFFERENTIAL mode helps locate the source of a detected IR signal.

Upon activation, the detected signal level will be set as "0" and the signal level bar will be showing the difference in excess of it.

To activate the DIFFERENTIAL mode press "ENTER". The level bar will change color to lilac.

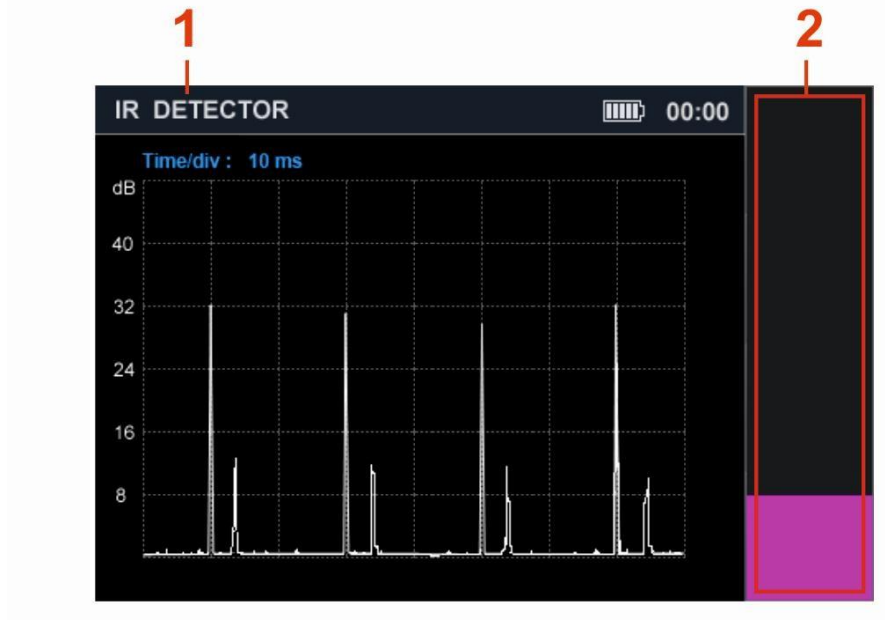

Fig.21

To exit DIFFERENTIAL mode, press "ENTER".

5. CONNECTING ST 500 TO CABLING

For connecting the Device to the tested circuits, various cables and adapters are supplied with ST 500. They are shown yellow in the figs. 22-27 below.

5.1. CONNECTING TO ELECTRIC MAINS

The device is connected to electric mains using an adapter ([fig.1, 2](#)), for "WIRED RECEIVER" channel ([6.3](#)).

The connection scheme is shown in fig.22.

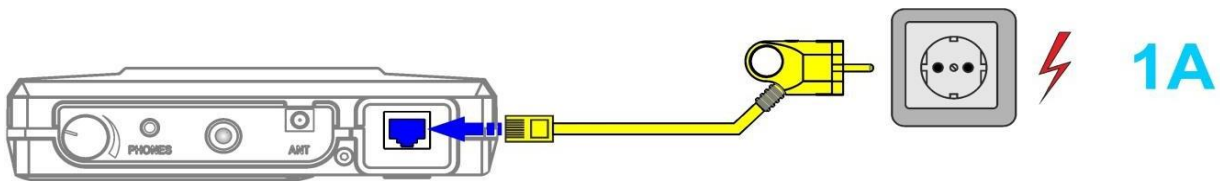

Fig.22

The adapter in an electric mains plug is connected to the mains socket, and the other end of the cable is connected to the "INPUT" socket of the main unit ([fig.2, 7](#)). A LED on the adapter will indicate if there is voltage on the circuit (lit if present).

5.2. CONNECTING TO LAN

CONNECTING TO LAN CABLES EQUIPPED WITH RJ45 PLUGS

When testing LAN cables without parallel connection of any end user devices (PCs, network printers, VoIP telephones, etc.) a LAN cable with RJ45 plug is connected to the "INPUT" socket of the main unit ([fig.2, 7](#)).

The connection scheme is illustrated in fig.23, 2A.

If a parallel connection of end user devices is necessary during testing, the following is used:

- cable for connecting the main unit to LAN sockets ([fig.1, 4](#))
- RJ45 splitter ([fig.1, 13](#))
- RJ45 coupler ([fig.1, 11](#)).

The connection scheme is shown in fig.23, 2B.

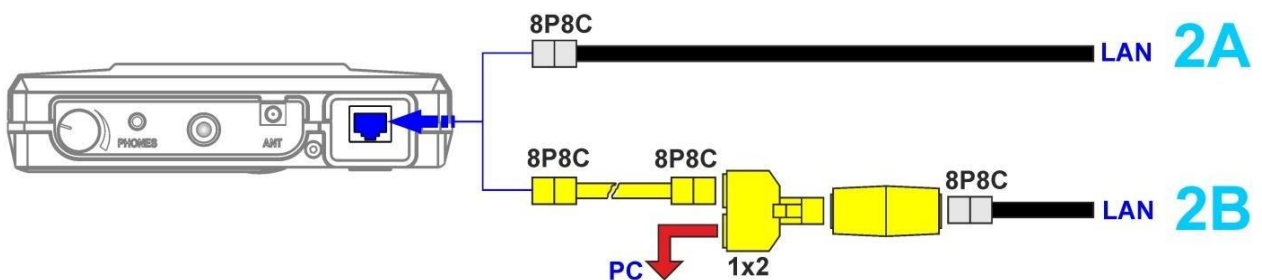

Fig.23

CONNECTING TO A LAN CABLE EQUIPPED WITH AN RJ45 SOCKET

When testing a LAN line without parallel connection of any end user devices, the Device is connected to the computer socket with a patch cord (fig.1, 4). The connection scheme is shown in fig.24, 2C.

If a parallel connection of end user devices is necessary during testing, the following is used:

- cable for connecting the main unit to LAN sockets (fig.1, 4)
- RJ45 splitter (fig.1, 13).

The connection scheme is shown in fig.24, 2D.

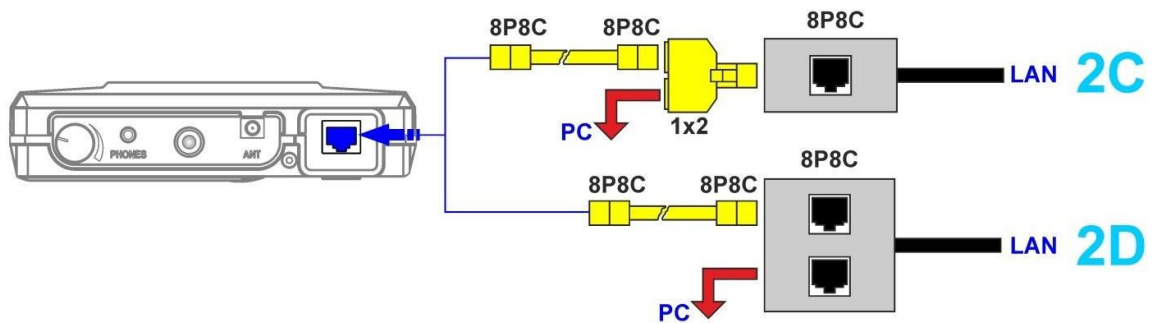

Fig.24

5.3. CONNECTING TO TELEPHONE LINES

Telephone lines can be equipped with **RJ11 plugs** or **RJ11 sockets**.

CONNECTING TO TELEPHONE LINE EQUIPPED WITH AN RJ11 PLUG

If there is no necessity in keeping a parallel connection of end user devices (telephone, fax), a cable fitted with an RJ11 plug (fig.1, 3) is connected to the Device through an RJ11 coupler (fig.1, 12). The connection scheme is shown in fig.25, 3A.

If a parallel connection of end user devices is needed during testing, the following is used:

- cable for connecting the main unit to telephone line sockets (fig.1, 3)
- RJ11 splitter (fig.1, 12)
- RJ11 coupler (fig.1, 10).

The connection scheme is shown in fig.25, 3B.

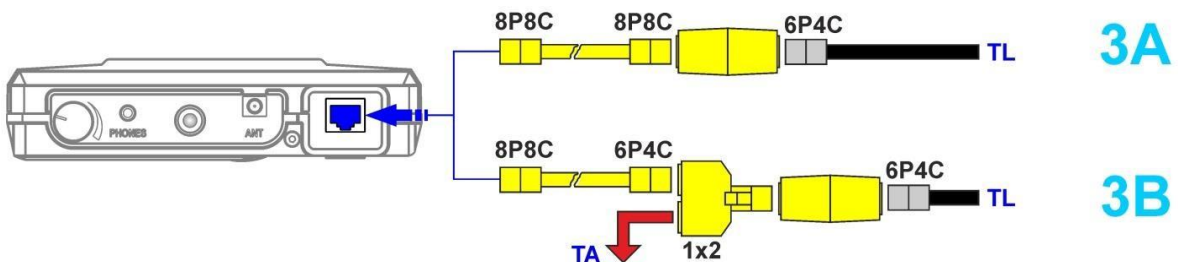

Fig.25

CONNECTING TO A TELEPHONE LINE EQUIPPED WITH AN RJ11 SOCKET

While testing telephone lines, if there is no necessity in a parallel connection of end user devices, a cable fitted with an RJ11 socket is cable-connected to the main unit ([fig.1, 3](#)). The connection scheme is shown in [fig.26, 3C](#).

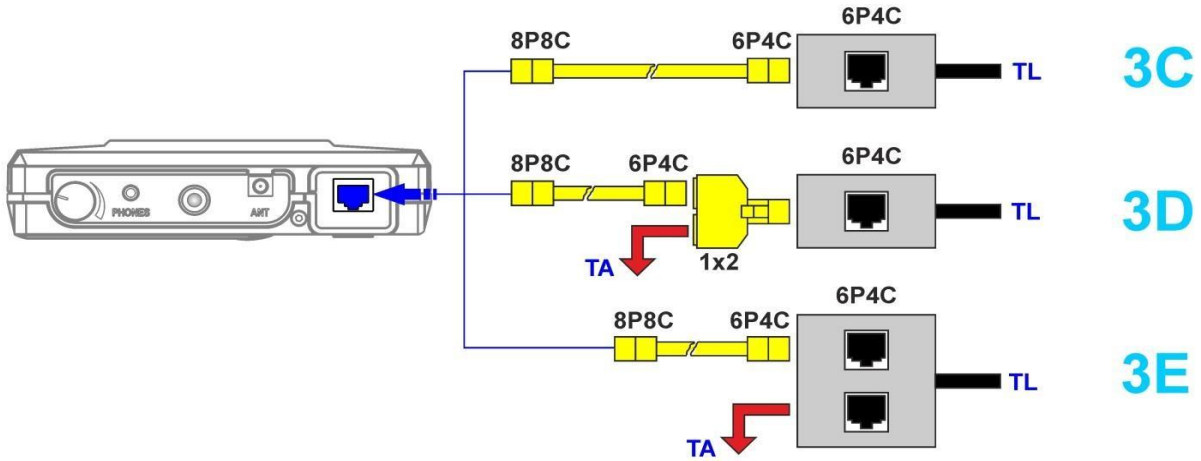

Fig.26

Ways of **parallel-connecting** to telephone lines, when end user devices (telephones or facsimile machines) need to be in operation, are shown in [fig.26, 3D and 3E](#).

The **3D** option is used when the telephone line is fitted with a **singular** RJ11 socket. An RJ11 splitter ([fig.1, 12](#)) and cable ([fig.1, 3](#)) are to be used in this case, for connecting the main unit.

The **3E** option is used, when telephone line is fitted with a **double** RJ11 socket. In this case, the Main Unit is connected to one of the two socket inlets through a special cable ([fig.1, 3](#)), while a telephone or facsimile machine is connected to the other through a standard cable.

5.4. CONNECTING TO LOW CURRENT MULTI-CORE CABLES NOT FITTED WITH CONNECTORS

For testing multiwire cables not equipped with either sockets or plugs, a special adapter ([fig.1, 16](#)) is used. The connection scheme is shown in [fig.27](#).

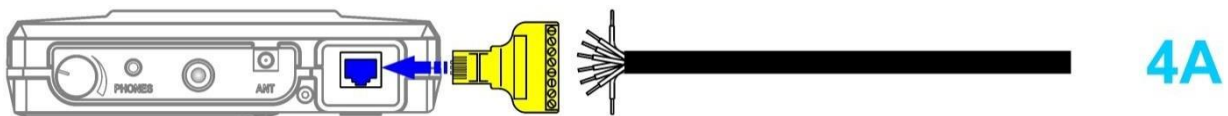

Fig.27

When connecting the LAN cable to the adapter, it is advised to observe the wiring color scheme shown in [Supplement #3](#).

6. THE "WIRED RECEIVER" CHANNEL

The "WIRED RECEIVER" channel is intended for the detection of signals from eavesdropping devices transmitting over electric mains and low current lines in the frequency range 0.1–180 MHz.

The detected signals are analyzed with the aid of

- visual information on the screen
- sounds (through headphones or the inbuilt speaker).

For connecting to electric mains, an adapter ([fig.1, 2](#)) is used.

For connecting to low current lines, cables ([fig.1, 3, 4](#)) are used.

The mode is activated from the main menu of device, after which it is necessary to determine:

- tested line type (electric mains or low current)
- frequency range (0.1 – 60 MHz or 0.1 – 180 MHz).

6.1. CIRCUIT TYPE SELECTION

Upon channel activation use the keys  and  to select the circuit type ("MAINS" or "LOW CURRENT") and press "ENTER".

A mains circuit is connected to the electronic switch through an adapter ([fig.1, 2](#)). Control of the electronic switch is disabled: only two cable cores are tested.

Low current circuits typically comprise multiwire cabling. Eavesdropping devices can be connected to certain paired combinations of wires. The Device is connected to those by means of the Electronic Switch.

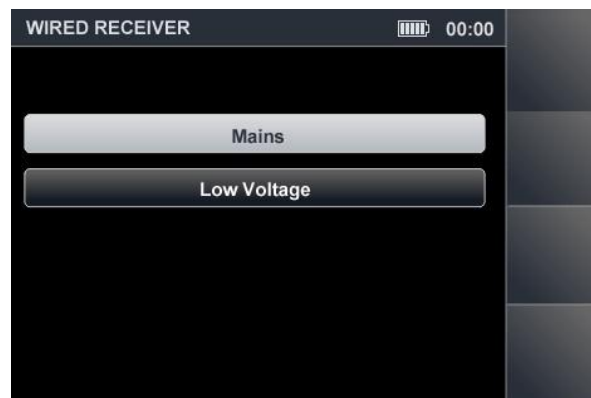

Fig.28

6.2. FREQUENCY RANGE SELECTION



Using  and  keys select one of the two frequency bands (0.1 – 60 MHz or 0.1 – 180 MHz) in which to search for signals, and press "ENTER". Fig.29 shows the frequency range selection menu.



Fig.29

ELECTRIC MAINS TESTING

FUNCTIONAL SCHEME OF THE "WIRED RECEIVER" CHANNEL (ELECTRIC MAINS TESTING)

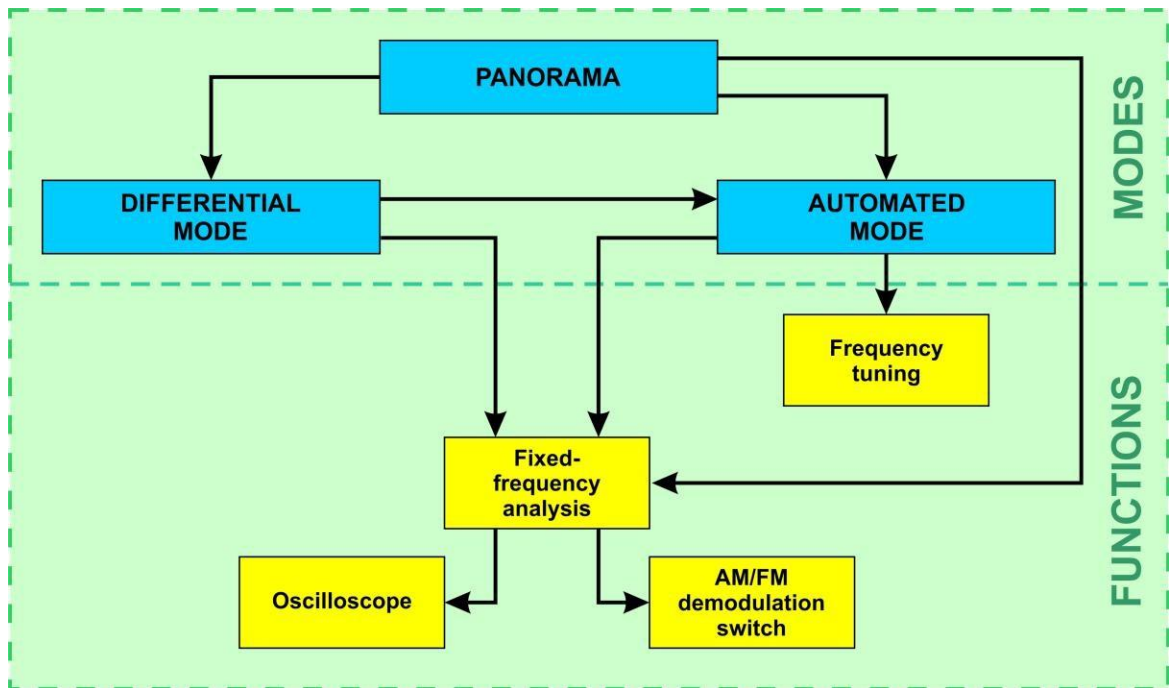

6.3. "PANORAMA" MODE (ELECTRIC MAINS TESTING)

When "MAINS" is chosen from the menu (fig.28), "PANORAMA" mode turns on, and all the signal activity in the circuit within the selected frequency band is displayed on the screen (fig.30).

Functionality:

- analyzing the signal at a set frequency
- obtaining a subtractive representation in the DIFFERENTIAL mode
- searching for signals in the AUTOMATED mode
- activating/deactivating the attenuator (20 dB)
- adjusting the band limits (zoom)

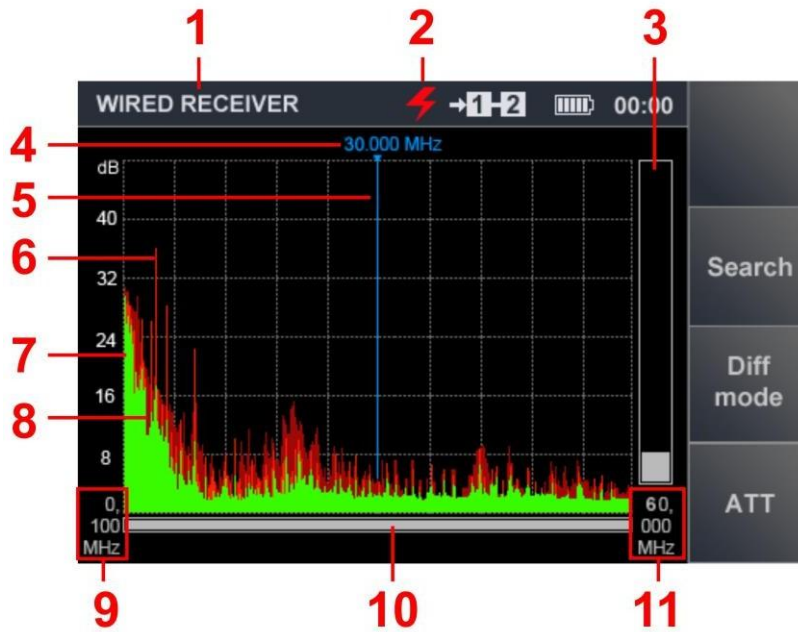

Fig.30

In fig.30:

- 1 - active detection channel
- 2 - electric mains selected
- 3 - signal level at the selected frequency
- 4 - frequency value at cursor position
- 5 - screen cursor
- 6 - pulse signals detected in the last measurement cycle (red)
- 7 - steady signals detected in the last measurement cycle (green)
- 8 - peak signal level at the given frequency over all cycles (maroon)
- 9 - lower zoom limit
- 10 - position of the selected band, as against maximum
- 11 - upper zoom limit

The graphics are periodically refreshed and show the signals received in the range selected for viewing. The constant and pulse components of signals registered during the latest cycle, are shown green and red, respectively.

Maximum signal levels, registered over the whole duration of monitoring the range, are colored maroon.

For more detailed scrutiny of a given segment, use the keys \leftarrow and \rightarrow to position the cursor at a signal of interest, or at the center of the segment, and zoom in using the \uparrow key.

The viewed range is displayed in digital (fig.30, 9 and 11) and graphic (fig.30, 10) representations. When the viewed range is changed, any previous data on peak signals (colored maroon) will be discarded. Use \downarrow for zooming out.

Controls

Key	Action
\downarrow \uparrow	setting the range (zoom)
\leftarrow \rightarrow	cursor positioning
F2	activating the AUTOMATED mode

Key	Action
F3	activating the DIFFERENTIAL mode
F4	activating/deactivating the attenuator (20 dB)
ENTER	turning on "FIXED FREQUENCY ANALYSIS" function
ESC, MODE	switching to the main menu of device
F1, FUNC	disabled

6.4. DIFFERENTIAL MODE

The DIFFERENTIAL mode is used to reduce the influence of external interference on the information signals, and evaluate changes in the activity within a band upon connecting new technical appliances to the circuit.

When the DIFFERENTIAL mode is activated, signal levels previously registered over the previous scanning cycles, are set as "0". After that only signal levels in excess of "0" will be displayed.

The DIFFERENTIAL mode is activated from "PANORAMA" by pressing "F3" (the key field will become lighter). The screen will look as shown in fig.31.

To deactivate the DIFFERENTIAL mode (return to "PANORAMA"), press "F3" (the key field will become darker). Attenuator and passband settings are saved.

Functionality:

- analyzing the signal at a set frequency
- search for signals in the AUTOMATED mode
- activating/deactivating the attenuator (20 dB)
- adjusting the band limits (zoom)

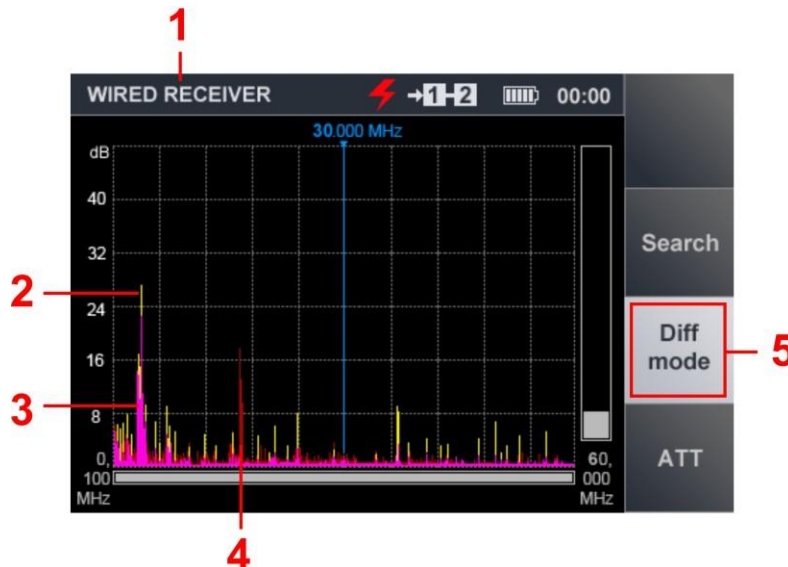

Fig.31

In fig.31:

- 1 - active detection channel
- 2 - differential spectrum of pulse signals obtained in the latest measurement cycle (yellow)
- 3 - differential spectrum of steady signals obtained in the latest measurement cycle (lilac)
- 4 - differential spectrum obtained over all previous measurement cycles (maroon)
- 5 - highlighting that indicates that the DIFFERENTIAL mode is on

Controls

Key	Action
↕ ↗	adjusting the band limits (zoom)
↔	cursor positioning
F2	activating the AUTOMATED mode
F3	deactivating the DIFFERENTIAL mode
F4	activating/deactivating the attenuator (20 dB)
ENTER	activating "FIXED FREQUENCY ANALYSIS" function
ESC, MODE	switching to the main menu of device
F1, FUNC	disabled

6.4.1. "FIXED FREQUENCY ANALYSIS" FUNCTION

This function is used for studying signals detected in the "PANORAMA" or DIFFERENTIAL mode. It allows listening to a demodulated (AM/FM) signal and researching it with the OSCILLOSCOPE.

The inclusion of the function is carried out from the "PANORAMA" or the DIFFERENTIAL mode. To activate it, use ↔ and ↔ to set the cursor at a given signal, and press "ENTER". The screen will look as shown in fig.32.

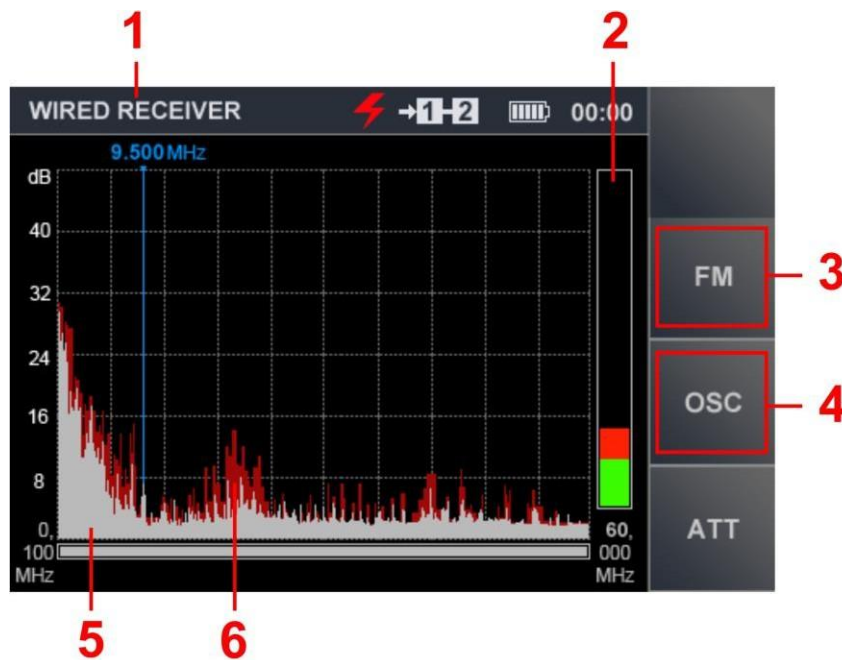

Fig.32

In fig.32:

- 1 - active detection channel
- 2 - signal level at the selected frequency
- 3 - "F2" (toggling AM/FM demodulation)
- 4 - "F3" (turn on OSCILLOSCOPE)
- 5 - spectrum obtained in the latest measurement cycle (grey)
- 6 - peak signal level at the given frequency over all cycles (maroon)

Functionality:

- activating/deactivating the attenuator (20 dB)
- AM/FM demodulation toggling
- researching signals with the OSCILLOSCOPE
- frequency tuning

Controls:

Key	Action
	cursor positioning (frequency tuning)
F2	toggling AM/FM demodulation
F3	turning on OSCILLOSCOPE
F4	activating/deactivating the attenuator (20 dB)
ENTER, ESC	turning on "FIXED FREQUENCY ANALYSIS" function
MODE	switching to the main menu of device

6.4.2. OSCILLOSCOPE

The OSCILLOSCOPE helps study a signal at a fixed frequency. To do this, press the "F3". After that, the "OSC" key field will become lighter. The screen view of the device is shown in fig.33.

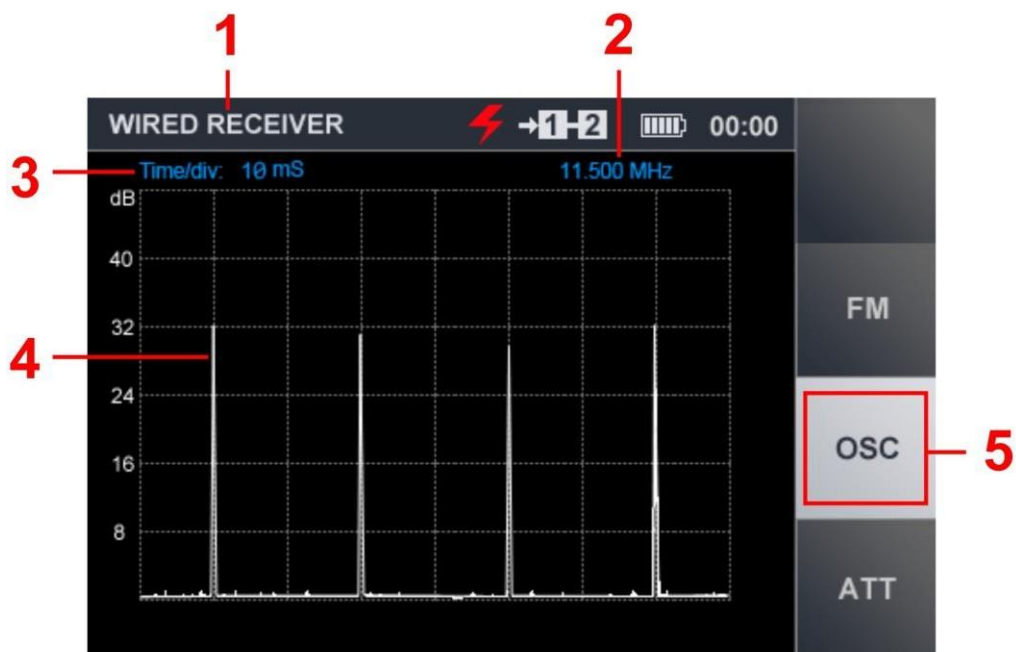
**Fig.33****In fig.33:**

- 1 - active channel
- 2 - selected frequency value
- 3 - set division value of the time axis
- 4 - oscillogram of the signal at the set frequency
- 5 - indication of the inclusion of the "OSCILLOSCOPE" function

Functionality:

- determining the time parameters of the demodulated signal
- setting the division value of the time axis
- listening to a demodulated (AM/FM) signal
- activating/deactivating the attenuator (20 dB)

Controls:

Key	Action
	setting the division value of the horizontal sweep 100µS/200µS/500µS/1mS/2mS/5mS/10mS
F2	toggling AM/FM demodulation
F3, ESC	turning off OSCILLOSCOPE
F4	activating/deactivating the attenuator (20 dB)
MODE	switching to main menu of device

6.5. AUTOMATED MODE

In the AUTOMATED mode, the signals are registered whose amplitude exceeds the adaptive detection threshold. Inclusion is made from the "PANORAMA" mode or from the DIFFERENTIAL mode, by pressing "F2". The screen view is shown in fig.34.

IMPORTANT! Search for signals is performed within the set boundaries, based on the readings obtained in the DIFFERENTIAL mode (if activated from the DIFFERENTIAL mode).

**Fig.34****In fig.34:**

- 1 - active channel
- 2 - number of the detected signals
- 3 - signal level, at current cursor position
- 4 - current table row
- 5 - current position as related to the total number of rows
- 6 - frequencies of the detected signals
- 7 - levels of the detected signals

Functionality:

- sorting of the detected signals (by frequency or by level)
- quick tuning to the detected signal by selecting it in the table
- frequency tuning
- activating/deactivating the attenuator (20 dB)
- AM/FM demodulation toggling
- researching signals with OSCILLOSCOPE

Controls:

Key	Action
	table row selection
FUNC	sorting signals
F2	toggling AM/FM demodulation
F3	turning on OSCILLOSCOPE
F4	activating/deactivating the attenuator (20 dB)
ENTER	turning on "FREQUENCY TUNING" function
ESC	switching to the previous mode
MODE	switching to main menu of device

6.5.1. "FREQUENCY TUNING" FUNCTION

For tuning to a frequency select the corresponding table row and press "ENTER".

Frequency tuning window (fig.35, 1) will appear. Using the keys  with a 10 kHz increment, set the frequency to obtain maximum response on the signal strength bar (fig.35, 2).

The function is turned off by pressing "ENTER" or "ESC".

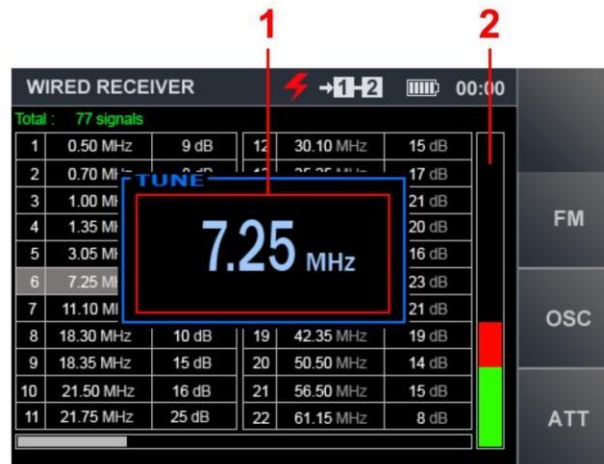
**Fig.35****6.5.2. OSCILLOSCOPE**

To analyze a demodulated signal using the "OSCILLOSCOPE" function, in the AUTOMATED mode table, place the cursor on the corresponding row and press "F3".

Functionality:

- determining the time parameters of the demodulated signal
- setting the division value of the time axis
- listening to an AM- or FM- demodulated signal
- on/off attenuator (20 dB).

Controls:

Key	Action
	setting the division value of the horizontal sweep 100µS/200µS/500µS/1mS/2mS/5mS/10mS
F2	toggling AM/FM demodulation
F3, ESC	turning off OSCILLOSCOPE
F4	on/off attenuator (20 dB)
MODE	switching to the main menu of device

To turn off the OSCILLOSCOPE, press "F3" or "ESC".

LOW CURRENT CIRCUIT TESTING

Low current circuits typically utilize multiwire cables. When searching for eavesdropping devices that may be connected to low current circuits, one should test all the possible paired combinations of wires.

**FUNCTIONAL SCHEME OF THE "WIRED RECEIVER" CHANNEL
(LOW CURRENT CIRCUITS TESTING)**

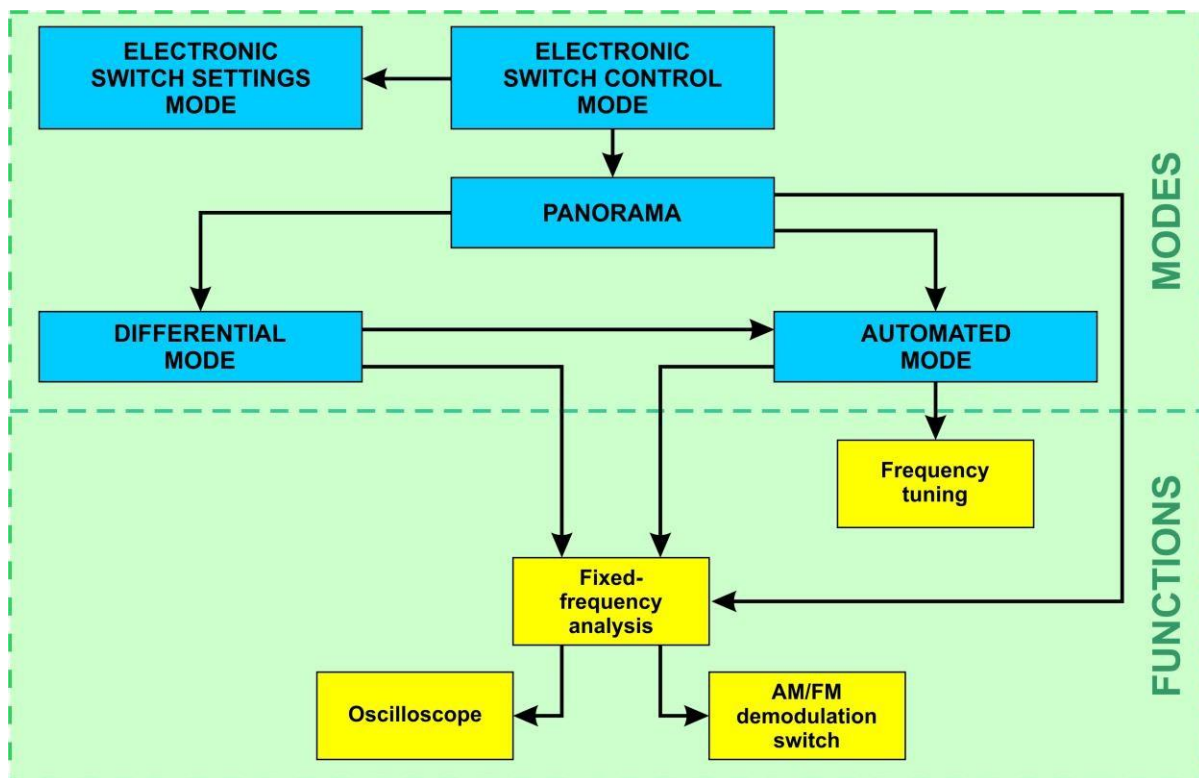
**6.6. "ELECTRONIC SWITCH CONTROL" MODE**

Upon selection of the "LOW VOLTAGE" menu item (6.1), the Device will switch to "ELECTRONIC SWITCH CONTROL" mode.

A table is displayed on the screen (fig.36), in which all combinations of wires of a multi-wire cable and measured DC and AC voltage values in each pair are presented.

If the voltage (Vdc) in the connected pair exceeds ± 50 V, the inscription ">50" appears in the corresponding cell.

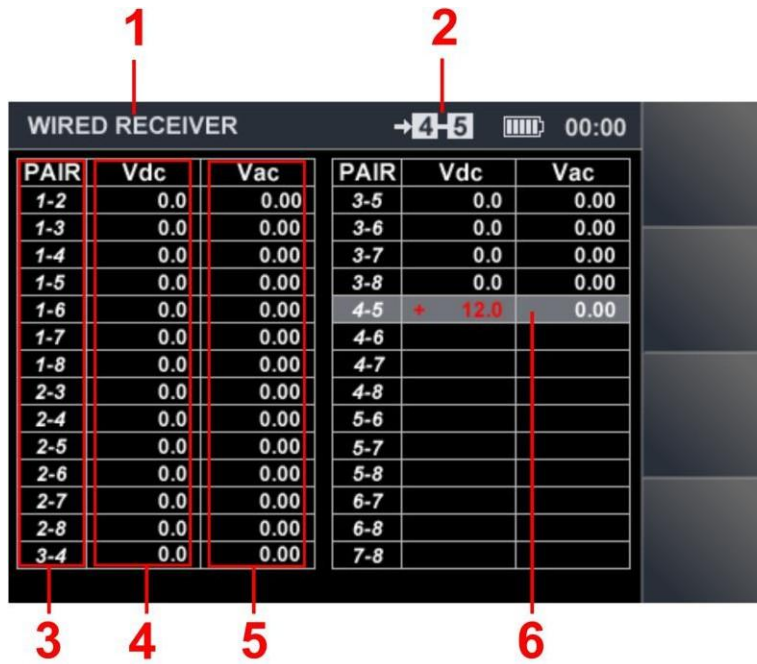

Fig.36

In fig.36:

- 1 - active channel
- 2 - pair of wires connected
- 3 - pairs of wires
- 4 - direct voltage on wire pairs
- 5 - alternating voltage on wire pairs
- 6 - current table row

Functionality:

- selecting a paired combination of wires
- analyzing signals in the selected pair
- electronic switch setup

Controls:

Key	Action
⏴ ⏵ ⏶ ⏷	table row selection (selecting a pair of wires to be tested)
ENTER	activating "PANORAMA" mode
ESC, MODE	switching to the main menu of device
FUNC	activating "ELECTRONIC SWITCH SETTINGS" mode
F1 - F4	disabled

To select a pair of wires, use the ⏴ ⏵ ⏶ ⏷ to set the table cursor to the corresponding row in the table. When the "ENTER" is pressed, the "PANORAMA" mode will be turned on and a panorama of the range loading in the selected pair of wires will be displayed on the screen.

6.7. "ELECTRONIC SWITCH SETTINGS" MODE

This mode is intended for setting up the electronic switch before testing low current multiwire cables. The setting-up procedure consists in choosing the pin numbers in the 8-pin socket of the electronic switch, to be connected to the cores of the cable under inspection. One of the four connection options for RJ connectors is thus chosen:

- 8P8C** – eight position connector (all 8 pins engaged)
- 6P6C** – six position connector (all 6 pins engaged)
- 6P4C** – six position connector (4 central pins engaged)
- 6P2C** – six position connector (2 central pins engaged)

RJ standard description is given in [Supplement #2](#)

If the tested cable is not equipped with connectors, or the connectors are non-standard, a **manual setup of the electronic switch** is possible.

Most common custom settings of the electronic switch are shown in [Supplement #2](#)

Electronic switch settings are not changed until switching to the Main menu of the device.

To activate "ELECTRONIC SWITCH SETTINGS" mode, press "FUNC". The screen will look as shown in fig.37 below.

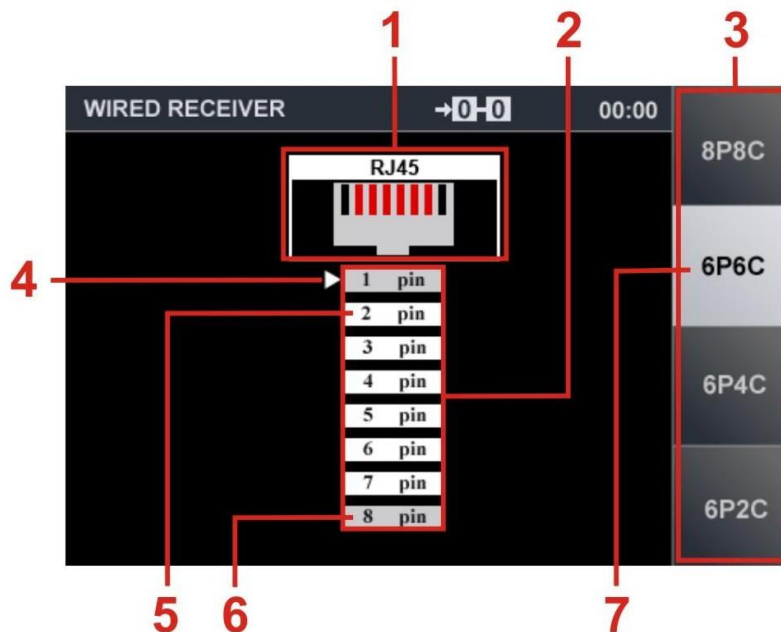

Fig.37

In fig.37:

- 1 - graphic representation of the input connector of the electronic switch
- 2 - adjustable list of electronic switch pins
- 3 - fields for turning on/off standard connection options
- 4 - current position marker
- 5 - connected pin (white background)
- 6 - disconnected pin (grey background)
- 7 - active standard connection scheme (highlighted)

Controls:

Key	Action
↙ ↘	navigation
ENTER	connecting/disconnecting the selected pin
F1	activating/deactivating the standard 8P8C scheme
F2	activating/deactivating the standard 6P6C scheme
F3	activating/deactivating the standard 6P4C scheme
F4	activating/deactivating the standard 6P2C scheme
ESC, FUNC	exiting the mode (to the previous screen)
↔, MODE	disabled

To finish the electronic switch setup and switch to "ELECTRONIC SWITCH CONTROL" mode, press "FUNC" or "ESC".

If any pins have been disengaged in the setting-up stage, upon switching back to "ELECTRONIC SWITCH CONTROL" mode, the table will look different.

Fig.38 shows the table, when the standard 6P6C connection scheme is used on the electronic switch: pins #1 and #8 are off, and no paired combinations that include these wire connections will be tested.

WIRED RECEIVER			→0-0	🔋	00:00
PAIR	Vdc	Vac	PAIR	Vdc	Vac
1-2			3-5		
1-3			3-6		
1-4			3-7		
1-5			3-8		
1-6			4-5		
1-7			4-6		
1-8			4-7		
2-3			4-8		
2-4			5-6		
2-5			5-7		
2-6			5-8		
2-7			6-7		
2-8			6-8		
3-4			7-8		

Fig.38**6.8. "PANORAMA" MODE (LOW CURRENT CIRCUIT TESTING)**

To activate the "PANORAMA" mode, in "ELECTRONIC SWITCH CONTROL" mode select the pair of wires to be monitored ([fig.36, 6](#)) and press "ENTER". Activity in the frequency band will be displayed on the screen ([fig.39](#)).

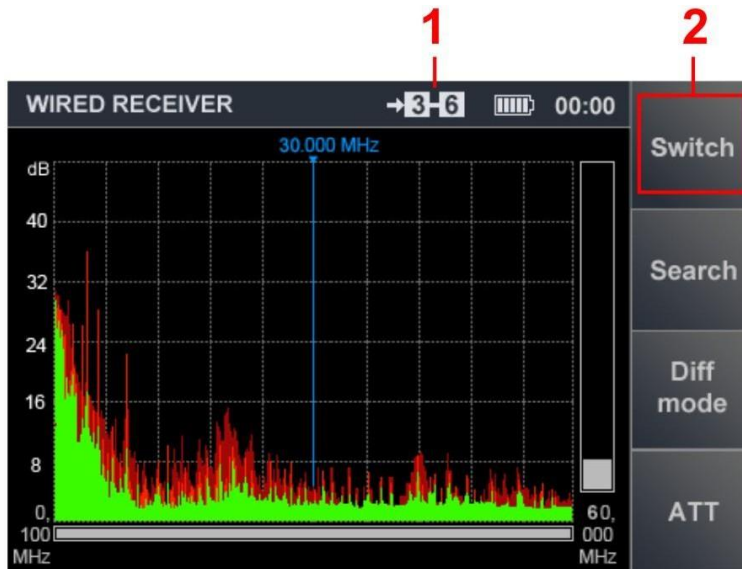

Fig.39

In fig.39:

- 1 - pair of wires connected
- 2 - key for returning to the previous screen

The "Switch" key is used to activate to the "ELECTRONIC SWITCH CONTROL" mode ([fig.36](#)) for connecting and analyzing another pair of wires.

Controls

Key	Action
↕	band setting (zoom)
↔	cursor positioning
F1	switching to "ELECTRONIC SWITCH CONTROL" mode
F2	activating the AUTOMATED mode
F3	activating the DIFFERENTIAL mode
F4	activating/deactivating the attenuator (20 dB)
ENTER	turning on "FIXED FREQUENCY ANALYSIS" function
ESC, MODE	switching to the main menu of device
FUNC	disabled

The operation modes (controls and functions) are similar to those **when testing electric mains.**

The "PANORAMA", DIFFERENTIAL and AUTOMATED modes are described in [6.3](#), [6.4](#), and [6.5](#), respectively.

7. "LOW FREQUENCY AMPLIFIER" CHANNEL

The "LOW FREQUENCY AMPLIFIER" channel is intended for the detection of low-frequency signals from eavesdropping devices in low current circuits.

An oscillogram, spectrogram and acoustic information are used to analyze the detected signals.

The channel is turned on from the main menu of the device ([fig.4](#))

FUNCTIONAL SCHEME OF THE "LOW FREQUENCY AMPLIFIER" CHANNEL

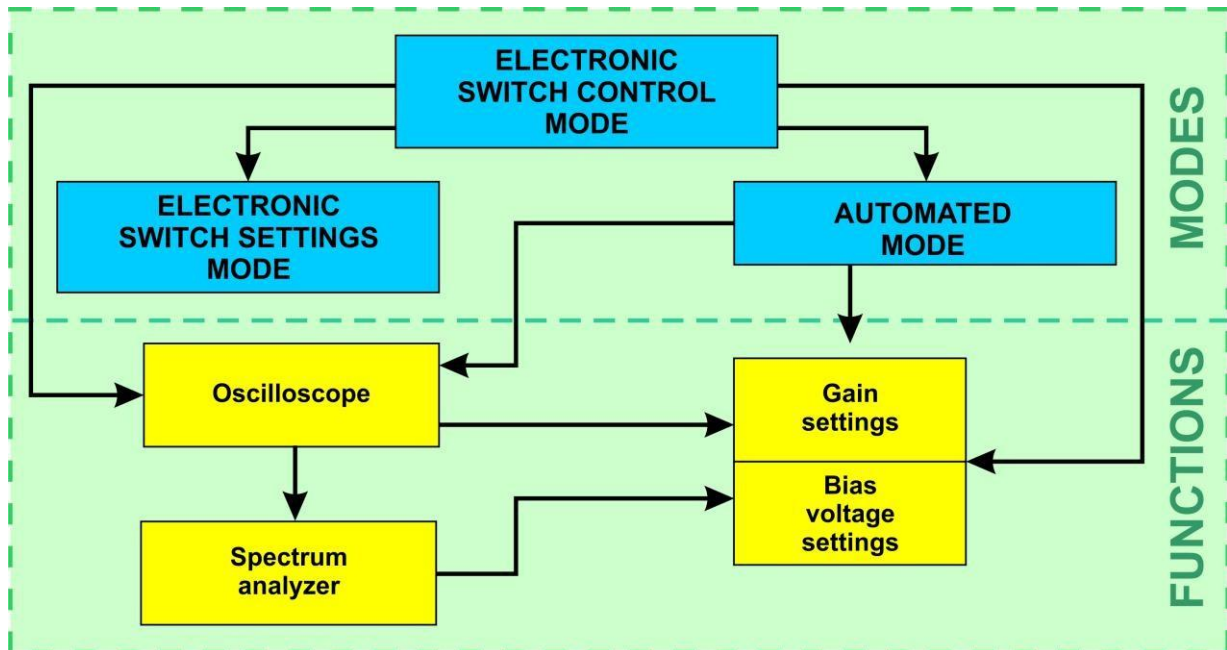

FUNCTIONALITY:

- electronic switch setup
- connecting pairs of wires in the manual mode
- automatic sequential selection of all paired wire combinations, with a possibility to analyze signals on each combination acoustically
- gain setting
- applying a bias voltage to the circuit
- acoustic analysis of the signal on the pair of wires connected to the Device
- measuring direct and alternating voltage on the pair of wires connected to the Device
- analyzing the signal on the pair connected to the Device by means of oscillogram and spectrogram

7.1. "ELECTRONIC SWITCH CONTROL" MODE

After the channel is turned on, the "ELECTRONIC SWITCH CONTROL" mode starts. The screen view is shown in [fig.40](#).

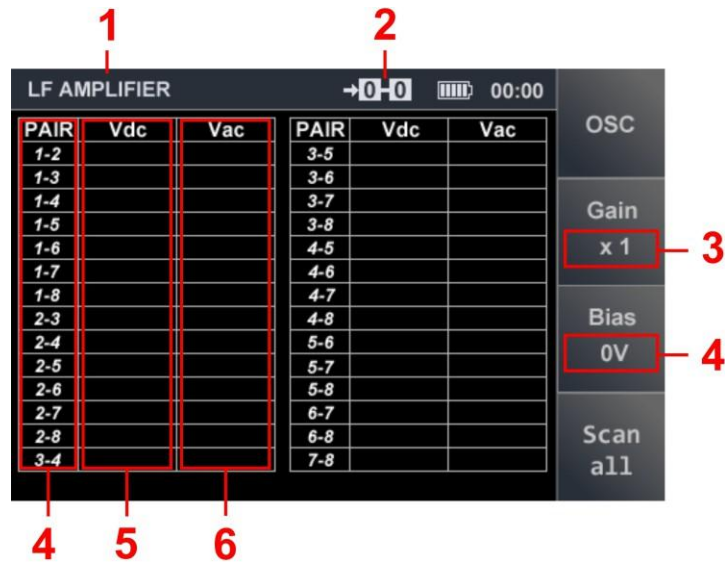

Fig.40

In fig.40:

- 1 - active channel
- 2 - pair of wires connected
- 3 - gain selected
- 4 - bias voltage selected
- 5 - wire pairs
- 6 - measured values of direct voltage
- 7 - measured values of alternating voltage

The measured values of direct and alternating voltage are shown for the pair of wires that is currently selected in the table (fig.41).

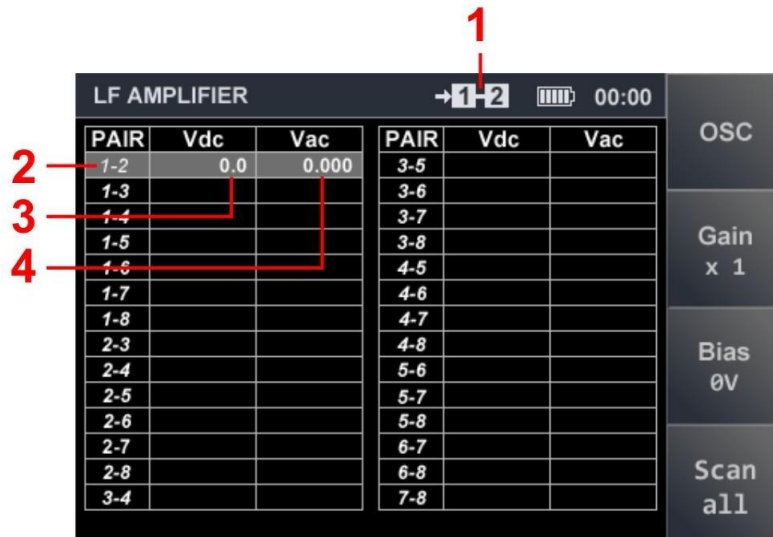

Fig.41

In fig.41:

- 1 - connected pair of wires
- 2 - current table row
- 3 - the value of the DC voltage
- 4 - the value of the AC voltage

Controls:

Key	Action
	table row selection (connecting pairs of wires)
F1, ENTER	turning on OSCILLOSCOPE
F2	gain setting on/off
F3	bias voltage setting on/off
F4	activating the AUTOMATED mode
ESC, MODE	switching to the main menu of device
FUNC	activating "ELECTRONIC SWITCH SETTINGS" mode

7.2. "ELECTRONIC SWITCH SETTINGS" MODE

Switching on the "ELECTRONIC SWITCH SETTINGS" mode is performed by pressing the "FUNC". The settings procedure is described in [6.7](#). This is what the screen looks like upon setting the electronic switch to the 6P4C scheme (fig.42). Pins #1, 2, 7, 8 are disabled (highlighted grey). The four central pins #3,4,5,6 are enabled (highlighted white).

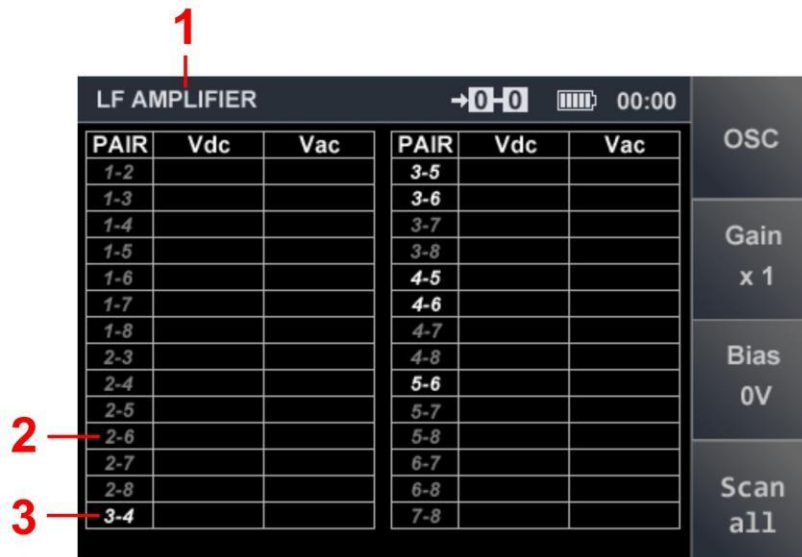
**Fig.42**

To finish the electronic switch setup and return to "ELECTRONIC SWITCH CONTROL" mode, press "FUNC" or "ESC".

7.3. SETTING THE GAIN

In order to set the gain value, do the following

1. Press "F2". The "Gain" field will become brighter.
2. Using the keys , set the desired gain multiplier (x1, x2, x5, x10, x20, x50, x100). The selected value will be shown on the screen (fig.43, 1).
3. If setting x1 gain is desired, press "ENTER".
4. When done, press "F2". The "Gain" field will become darker.

Important! While setting the gain, other features are inaccessible.

The screen view when setting the gain value is shown in fig.43.



Fig.43

The selected gain value remains unchanged until next adjustment or "LOW FREQUENCY AMPLIFIER" channel deactivation (return to main menu of device).

7.4. SETTING THE BIAS VOLTAGE

In order to apply a bias voltage to a connected pair of wires, do the following

1. Press "F3". The "Bias" field will become brighter.
2. Using the keys \downarrow \uparrow select the bias voltage (-30 V or +30 V) which will be displayed on the screen (fig.44, 1 and 2). The bias voltage value will be marked green, and voltage in the circuit will be marked white.
3. To reverse the sign of the bias voltage, use \leftarrow or \rightarrow .
4. To set "0" value, press "ENTER".
5. To finish, press "F3". The "Bias" field will become darker.

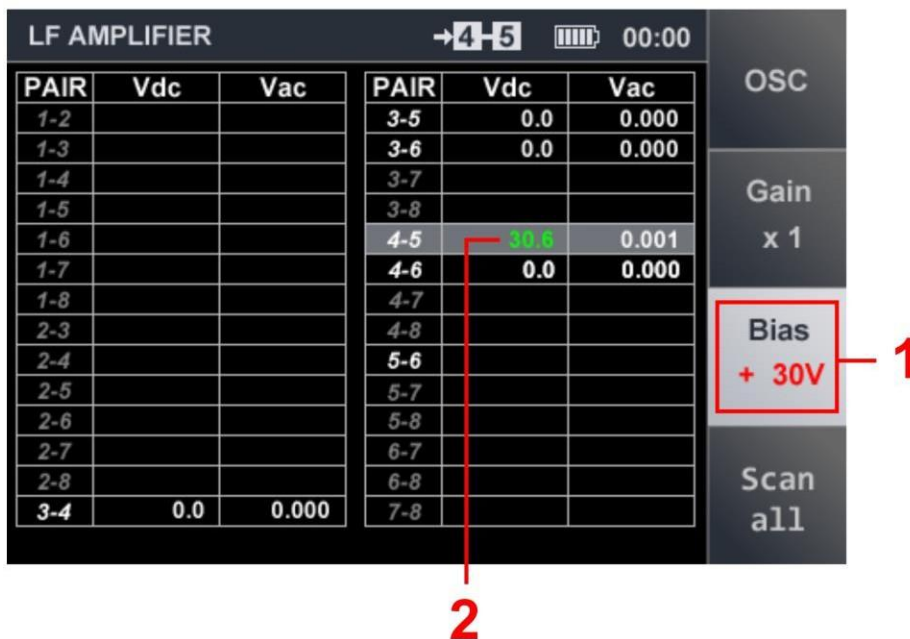

Fig.44

Important! While setting the bias voltage, other functions will be inaccessible.

The bias voltage, once set, will remain unchanged until deactivation of the "LOW FREQUENCY AMPLIFIER" channel (switching to the main menu of device).

If the voltage on the pair connected to the ST 500 is beyond ± 3 V, the application of bias voltage to these wires is disabled.

The measured voltage value will in this case be marked red (fig.45, 3). When this pair is engaged (by selecting the corresponding table row) a red sign reading "OVER" will appear in the upper-center part of the screen (fig.45, 2) and the "F3" key field will look as shown in fig.45, 4.

If the voltage (Vdc) in the connected pair exceeds ± 50 V, the inscription ">50" appears in the corresponding cell.

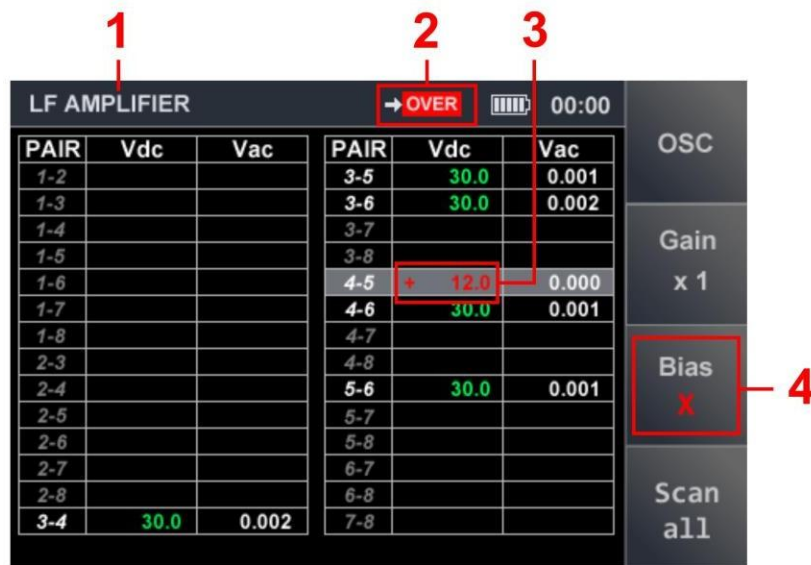

Fig.45

In this case, to apply a bias voltage, de-energize the cable.

7.5. AUTOMATED MODE

The AUTOMATED mode is intended for cycling through all possible paired combinations of wires in a multicore cable.

To activate this feature, press "F4" ("Scan all") (fig.40). The electronic switch will consecutively engage all the pairs of wires, staying for several seconds at each of them (each time the corresponding table row will become active).

The user can analyze the received signal by listening to the output sound.

If during scanning suspect signals have been detected, when the cycle is over, they should be analyzed by means of "OSCILLOSCOPE" and "SPECTRUM ANALYZER".

7.6. OSCILLOSCOPE

The OSCILLOSCOPE is activated from "ELECTRONIC SWITCH CONTROL" mode or the AUTOMATED mode by pressing "F1".

Upon activation, the screen will look as shown in fig.46.

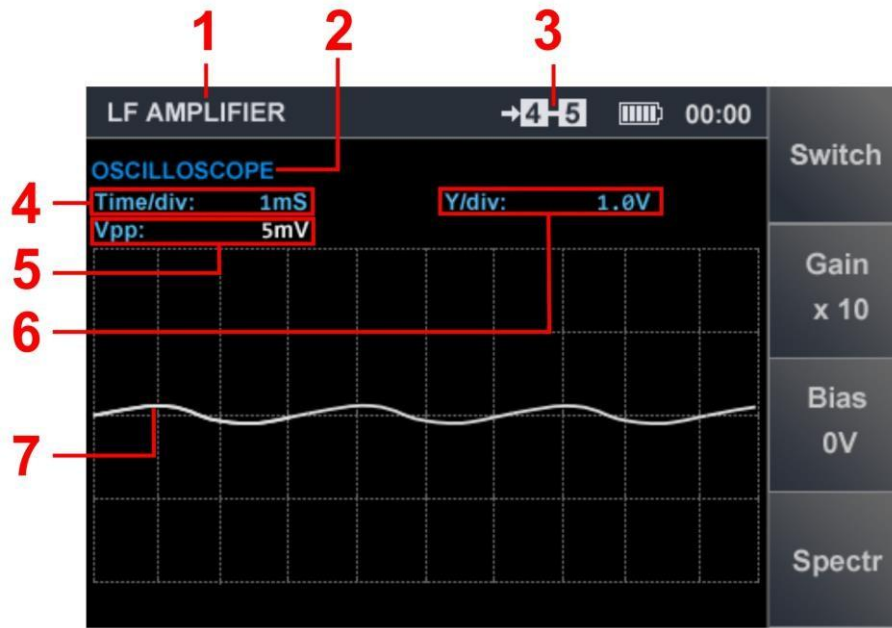

Fig.46

In fig.46:

- 1 - active channel
- 2 - data representation form
- 3 - connected pair of wires
- 4 - set division value of the time axis (mcs or ms)
- 5 - measured value of signal magnitude
- 6 - vertical zoom
- 7 - oscillogram

Upon activation of the OSCILLOSCOPE, the gain value and bias voltage, set in the "ELECTRONIC SWITCH CONTROL" mode, are retained. Both these parameters can be adjusted without exiting the OSCILLOSCOPE. The adjustment procedure is described in 7.3.1. and 7.3.2.

Controls:

Key	Action
	vertical zoom of the OSCILLOSCOPE
	horizontal zoom of the OSCILLOSCOPE
F1, ESC	switching to "ELECTRONIC SWITCH CONTROL" mode
F2	activating/deactivating Gain Setting
F3	activating/deactivating Bias Voltage Setting
F4	activating "SPECTRUM ANALYZER" function
MODE	switching to the main menu of device
FUNC, ENTER	disabled

7.7. SPECTRUM ANALYZER

The SPECTRUM ANALYZER is activated from the OSCILLOSCOPE by pressing "F4" ("Spectr"). The screen will look as shown in fig.47.

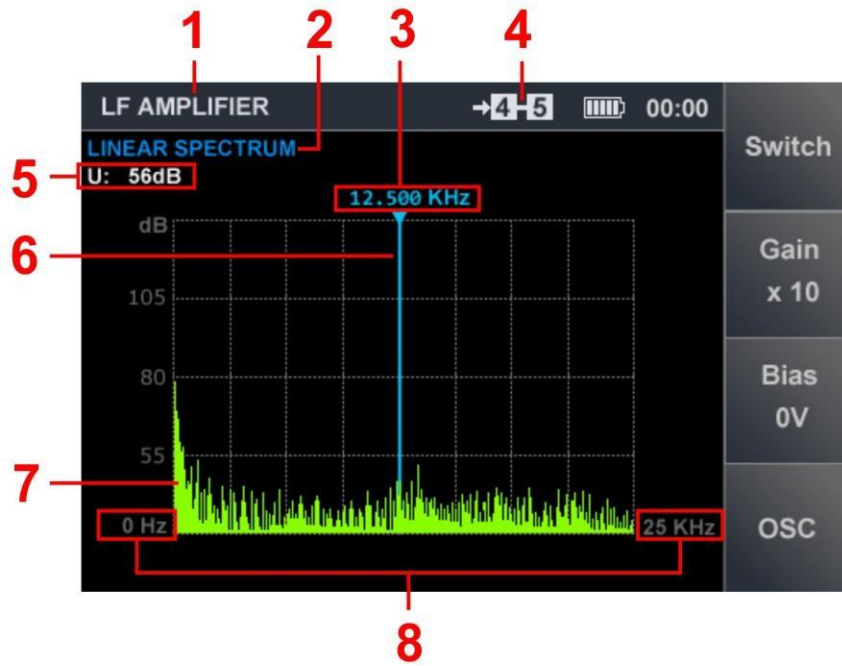

Fig.47

In fig.47:

- 1 - active channel
- 2 - data representation form
- 3 - frequency value at cursor position
- 4 - connected pair of wires

SPECTRUM ANALYZER Controls

Key	Action
	cursor positioning
F1, ESC	switching to " ELECTRONIC SWITCH CONTROL " mode
F2	activating/deactivating Gain Setting
F3	activating/deactivating Bias Voltage Setting
F4	activating OSCILLOSCOPE
MODE	switching to the main menu of device

8. SOFTWARE

8.1. PURPOSE

1. Preparation and loading into ST 500 of a priori information for analyzing the received signals using the "SELECTIVE HF DETECTOR" channel in AUTOMATED and "WIRELESS COMMUNICATION" modes:

- adjustment of "THREAT" and "NON-THREAT" frequency bands,
- customizing the parameters frequency bands used by digital communications devices,
- customizing the parameters of frequency bands used by base stations of mobile communications networks,
- making/editing user lists.

2. Updating the firmware of the main unit processor.

8.2. FUNCTIONALITY

The user can do the following

1. Adjust the factory settings, then download the data to the device and/or save them as a file on the HDD.
2. Download data from the ST 500 or from the HDD, make the necessary changes, then upload the corrected data to the device and/or save it as a file on the HDD.

Files on the HDD are saved in the "xxx.dat" format, ("xxxx" is the file name assigned by the user when saved).

Only one file can be downloaded to the device, an unlimited number of files can be saved to the HDD.

8.3. PC REQUIREMENTS

Operation System: Windows 7, 8, 10 (64 bit)

Free HDD space: at least 100 Mb

8.4. INSTALLATION

The distribution kit is located in the Prog_ST500 folder on the flash card supplied.

Installation Order:

1. Copy the Prog_ST500 folder to the PC.
2. Install the ST 500 driver on the PC (run the CDM21228_Setup.exe file).
3. Run the ST500.exe file.
4. Using the USB cable (fig.1, 5) connect the ST 500 main unit to the PC.
5. Turn on the main unit.

On the PC screen (on the status bar (fig.48, 7) should appear the inscription: "USB connected". The following message should appear on the screen of the ST 500: "USB connected". After that, the software is considered to be successfully installed on the PC.

8.5. GRAPHICAL INTERFACE

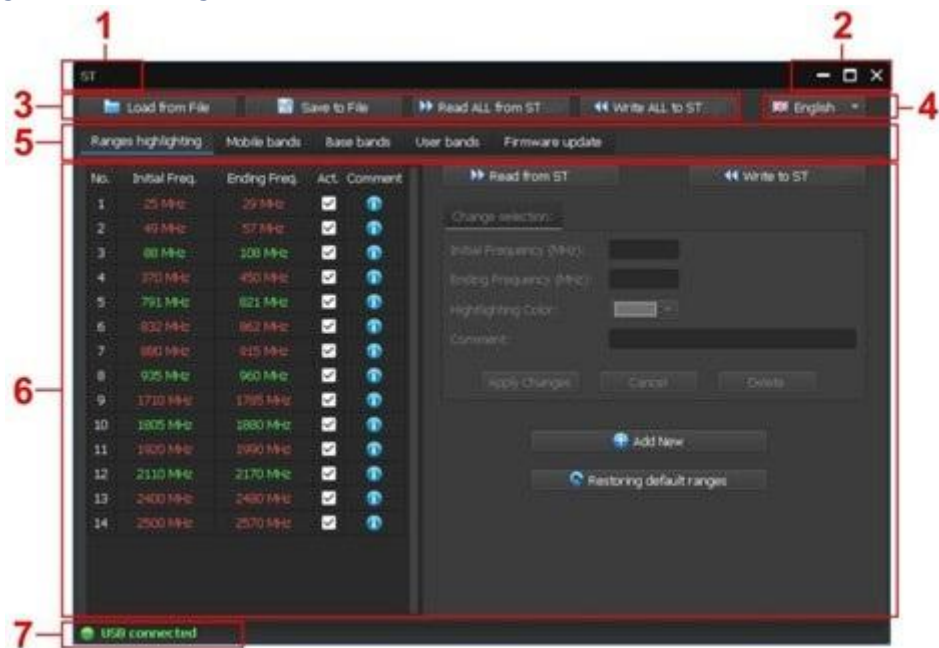

The PC screen with running ST 500 software is shown in fig.48.

Fig.48

In fig.48:

- 1 - software name
- 2 - application window control (minimize, maximize, close)
- 3 - mode tabs
- 4 - language setting
- 5 - software mode tabs
- 6 - data field and controls in the active mode
- 7 - status bar (connecting ST 500 to PC)

The status bar (fig.48, 7) can indicate one of the three states:

1. **"USB Connected"**: the Main Unit is on and connected to the computer.
2. **"Request to connect to ST500..."**: the PC sends a request to connect the main unit (the driver is installed, the main unit is turned off and connected to the PC).
3. **"No response from ST500!"**: The response of the ST 500 to the PC request is not received (the main unit is not connected to the PC and/or turned off and/or the driver is not installed).

8.6. OPERATION MODES

1. "RANGES HIGHLIGHTING" mode
2. "MOBILE BANDS" mode
3. "BASE BANDS" mode
4. "USER BANDS" mode
5. "FIRMWARE UPDATE" mode

The inclusion of the mode is made by switching to the appropriate tab (fig.48, 5).

8.6.1. "RANGES HIGHLIGHTING" MODE

This mode is intended for defining the limits of bands in which the presence of "THREAT" or "NON-THREAT" signals is likely.

"THREAT" bands:

- operating frequency bands of digital mobile communications devices
- operating frequency bands of mobile cell phone base stations
- known frequency bands utilized by eavesdropping devices

"NON-THREAT" bands:

- operating frequency bands of base stations of mobile communications networks
- broadcasting bands of television and radio stations
- operating frequency bands of various radio devices in legitimate use on site

"THREAT" frequency bands are highlighted red, "NON-THREAT" bands are highlighted green.

Once information on "THREAT" and "NON-THREAT" bands is loaded into ST 500, signals listed in the AUTOMATED mode table of the SELECTIVE HF DETECTOR (3.6), will be highlighted accordingly. If a signal is detected in a "THREAT" band it is highlighted red, if in a "NON-THREAT BAND", green.

If a signal's frequency falls within neither of these bands, the signal is classified as "UNKNOWN" and highlighted white.

If search for eavesdropping devices is conducted on the site on a regular basis, it is advisable to save band assignments in data files.

The mode is activated by selecting the "RANGES HIGHLIGHTING" tab. The screen upon mode activation is shown in fig.49.

Fig.49

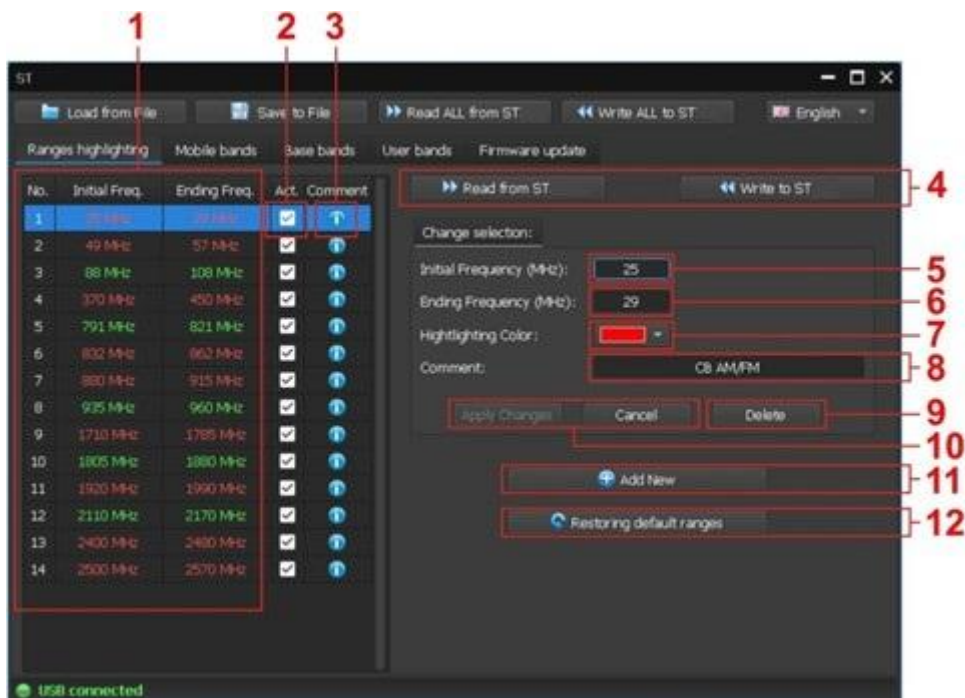

In fig.49:

- 1 - list of highlighted ranges: sequence number, initial (lower) and ending (upper). The line of the adjustable range is highlighted in blue
- 2 - activity checkbox. If not ticked: signals found in this range will be classified as "UNKNOWN"
- 3 - info button showing a user comment left while editing the range
- 4 - controls for data exchange with DEVICE
- 5 - input field for initial (lower) frequency
- 6 - input field for ending (upper) frequency
- 7 - text color selection box (red or green)
- 8 - input field for comments (only numbers and Latin letters can be used)
- 9 - band deletion (the active line highlighted blue will be deleted)
- 10 - accepting/canceling changes made
- 11 - adding a new range
- 12 - return to factory settings of the "RANGES HIGHLIGHTING" mode

USING THE "RANGES HIGHLIGHTING" MODE

1. Go to "RANGES HIGHLIGHTING" tab.
2. Load data by one of the below methods:
 - from the PC, by clicking "Load from File" and selecting the file; all the data including range customizations will be loaded
 - from ST 500, by clicking "Read ALL from ST500"; all the data including range customizations will be loaded
 - from ST 500, by clicking "Read from ST500"; only range customizations will be loaded
 - from ST 500, by clicking "Restoring default ranges"; list of ranges set by the manufacturer will be loaded.

Parameter adjustment

1. To edit a band, select the corresponding table row, which will be highlighted blue
2. Edit the following parameters:
 - initial (lower) and/or ending (upper) frequency band (fig.49, 5, 6)
 - highlighting color (fig.49, 7)
 - comment (fig.49, 8)
 - on/off activity checkbox (fig.49, 2)
3. Click "Apply Changes" to save the adjustments, or "Cancel" to exit without saving changes.

Adding a new band

1. Click "Add New"
2. Input new band parameters:
 - lower and upper frequency bounds (fig.49, 5,6)
 - highlighting color (fig.49, 7)

- comment (fig.49, 8)
- on/off activity checkbox (fig.49, 2)

3. Click "Apply Changes" to save the changes made, or "Cancel" to exit without saving changes

Restrictions for band editing or addition

1. Frequency ranges cannot border on, or overlap with, one another. If this restriction is not met, the following warning prompt will appear,

"Initial Frequency is in a different range # xx (xxx - xxx)"

"Ending Frequency is in a different range # xx (xxx - xxx)"

2. The width of a range cannot exceed 200 MHz. If this restriction is not met, the following warning prompt will appear,

"The range should be no more than 200 MHz!"

Deleting a band

To delete a band, select the corresponding table row and click "Delete". Upon confirmation the line will be deleted from the list.

Finishing

Before completing the work, save the changes in any of the following methods:

- download to the PC HDD by clicking the "Save to File" and specifying the path for saving and the file name (information about the selected ranges and information from other modes will be saved);
- download to the ST 500 only information on the made adjustments of the selected ranges by clicking "Write to ST500";
- download to the ST 500 information about all the lists (in all modes) by clicking "Write ALL to ST500".

8.6.2. "MOBILE BANDS" MODE

This mode is intended for creating and editing a list of frequency bands utilized by mobile communication systems in the region.

This information, downloaded to ST 500, is used by the SELECTIVE HF DETECTOR channel, "WIRELESS COMMUNICATION" mode, "MOBILE DEVICES MONITORING" function ([3.4.1](#)).

The mode is activated by selecting the "Mobile bands" tab. The device screen will look as shown in fig.50.

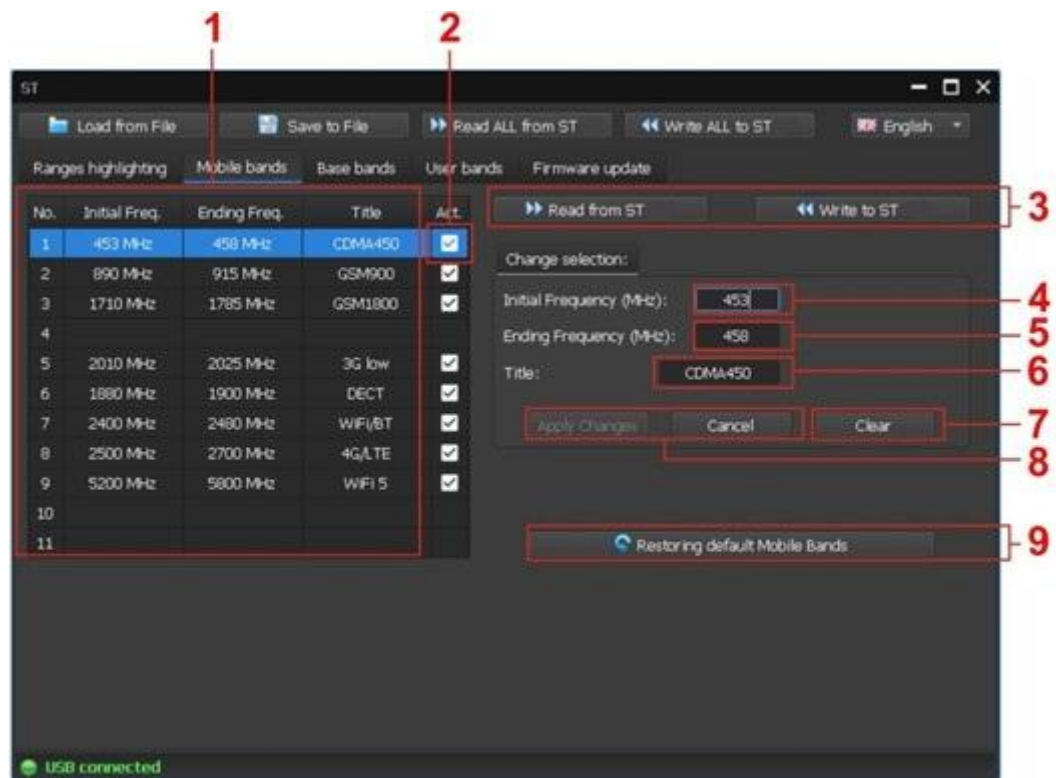

Fig.50

In fig.50:

- 1 - list of frequency bands of mobile devices: sequence number, initial (lower) and ending (upper) frequencies, range designation. The line of the adjustable range is highlighted in blue
- 2 - activity checkbox. If not ticked: no search for signals in this range
- 3 - control of data exchange with ST 500 (reads and writes data relating only to the "Mobile bands" mode)
- 4 - input field for initial (lower) frequency
- 5 - input field for ending (upper) frequency
- 6 - input field for range designation (only numbers and Latin letters can be used)
- 7 - band deletion
- 8 - accepting or canceling changes made
- 9 - download factory settings

USING THE MODE "MOBILE BANDS"

1. Go to tab "Mobile bands". The PC screen will look as shown in fig.50
2. Download data in any of the following ways:
 - from the PC, by clicking "Load from File" and selecting the file; all the data including range customizations will be loaded
 - from ST 500, by clicking "Read ALL from ST500"; all the data including range customizations will be loaded
 - from ST 500, by clicking "Read from ST500"; only band customizations will be loaded
 - from ST 500, by pressing "Restoring default Mobile Bands"; manufacturer-defined presets will be loaded.

Changing parameters

1. To edit a band in the list, select the corresponding table row, which will be highlighted blue.
2. Edit parameters:
 - initial (lower) and/or ending (upper)band frequency (fig.50, 4,5)
 - name or comment on the band (fig.50, 6)
 - tick highlighting on/off (fig.50, 2)
3. Press "Apply Changes" to save the changes, or "Cancel" to exit without saving changes.

Adding a new band

1. Set the cursor to the "empty" line.
2. Input band parameters:
 - initial (lower) and ending (upper) band frequency (fig.50, 4,5)
 - name or comment on the band (fig.50, 6)
 - tick highlighting on/off (fig.50, 2)
3. Click "Apply Changes" to save the changes, or "Cancel" to exit without saving changes.

Restrictions for band editing or addition:

1. The maximum number of bands (list rows) is 11.
2. The band should not exceed 600 MHz. If this condition is violated, a warning appear on the screen:

"The band should be no more than 600 MHz!"

3. The value of the initial frequency must be less than the ending frequency. If this condition is violated, a warning appear on the screen:

"Initial Frequency > Ending Frequency!"

Deleting a band

To delete a band, place the cursor on the corresponding line and click "Clear" and then confirm the action.

Finishing

Save changes by one of the below methods:

- download to PC's HDD by clicking the "Save to File" and specifying the path to save and the name of the file (the list of mobile devices and information from other modes will be saved)
- download only the information about the made adjustments of the ranges of mobile devices in the memory of the ST 500 by clicking the "Write to ST500"
- download information about all lists (in all modes) into the memory of the ST 500 by clicking the "Write ALL to ST500"

8.6.3. "BASE BANDS" MODE

This mode is intended for creating and editing a list of frequency bands utilized by mobile communication systems in the region.

These data loaded to ST 500 memory, are used by the SELECTIVE HF DETECTOR channel, "WIRELESS COMMUNICATION" mode, "BASE STATIONS MONITORING" function (3.4.2). To activate the mode, select the "Base bands" tab.

The order of loading, updating, saving data and limiting is similar to the procedures described in 8.6.2.

8.6.4. "USER BANDS" MODE

This mode is intended for creating and editing a list of frequency bands that are of a specific interest to the user. These data loaded to ST 500 memory, are used by the SELECTIVE HF DETECTOR channel, "WIRELESS COMMUNICATION" mode, "USER LIST" function (3.4.3). To activate the mode, select the "User bands" tab.

The order of loading, updating, saving data and limiting is similar to the procedures described in 8.6.2.

8.6.5. "FIRMWARE UPDATE" MODE

The current firmware version is shown on the screen when the device is turned on (fig.51).



Fig.51

Get information and download the latest version of the firmware can be on the SELCOM SECURITY official site: <https://www.selcomsecurity.com/support/>

When "Firmware update" is on, the screen looks as shown in fig. 52 below.

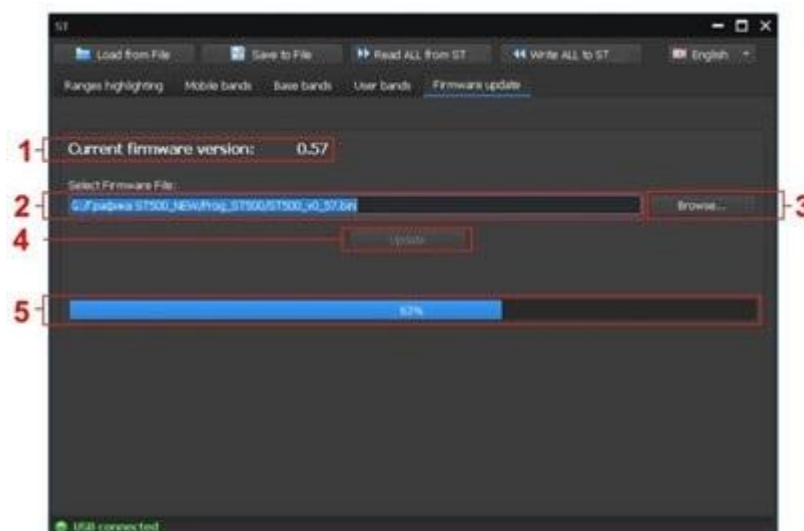

Fig.52

In fig. 52:

- 1 – current firmware version
- 2 – path to the latest firmware file
- 3 – browsing button
- 4 – update start button
- 5 – update progress bar

To update the firmware

1. Download to PC from our official site: <https://www.selcomsecurity.com/support/> file **ST500_vx_xx.bin** ('x_xx' is version number)
2. Start ST 500 software.
3. Connect ST 500 to PC.
4. Select tab "Firmware update".
5. Click "Browse".
6. In the opened window select the path to the file with latest firmware version and click "Open". The file name and path will be shown on screen (fig.52, 2).
7. Click "Update". The progress will be shown on screen (fig.52, 5). Upon completion you will be prompted, "Update done!".
8. Click "OK".
9. The new firmware version will be shown in the corresponding field (fig.52, 1).

9. USE GUIDELINES

9.1. GUIDELINES FOR USE OF "SELECTIVE HF DETECTOR" CHANNEL

The "SELECTIVE HF DETECTOR" channel is intended for detection, identification and localization of radio transmitting, "active" eavesdropping devices in the range of 20 - 6000 MHz.

Three options of searching for eavesdropping devices:

- AUTOMATED mode
- manual modes ("PANORAMA" or DIFFERENTIAL mode)
- search in previously known frequency ranges (in the "WIRELESS COMMUNICATION" mode).

Three stages in the search for eavesdropping devices:

stage #1 - detection of the signal

stage #2 - identification of the detected signal ("threat"/"non-threat")

stage #3 - localization of the source of a dangerous signal

The presented search algorithms are typical and can be adjusted depending on the features of the object being checked and the tasks set.

9.1.1. SEARCH IN THE AUTOMATED MODE

The AUTOMATED mode is used at small loading of a frequency range in the area of search

SEARCH ALGORITHM:

1. In the checked room:
 - activate the test sound source and adjust the sound volume
 - connect the antenna and headphones to the main unit of ST 500
 - turn on ST 500
2. Turn on "SELECTIVE HF DETECTOR".
3. Depending on the activity in the frequency range, set the optimal gain, making sure that no off-scale occurs.
4. Turn on the AUTOMATED mode.
5. Sort the table by signal level in ascending order.
6. Select the first table row as current.
7. Analyze the demodulated signal as follows:
 - listen to the signal in headphones at different passband (1 and 20 MHz)
 - analyze the signal with the oscilloscope
 - fine tune the frequency if necessary

Signs of "THREAT" signal:

- at the frequency of the detected signal, the test sound is heard through the headphones,
 - the test sound is not heard in the headphones, but the oscilloscope picture of the demodulated signal changes with the test sound,
 - the detected signal is marked red in the table, which means that a mobile digital device is nearby, or the signal is within the band utilized by radio-transmitting eavesdropping devices,
 - there is a radical decrease in the level of the detected signal when ST 500 is brought outside the checked room.
8. Analyze all the other signals in a similar way.

9.1.2. SEARCH IN THE "PANORAMA" MODE AND DIFFERENTIAL MODE

The "PANORAMA" and DIFFERENTIAL mode are used to search for eavesdropping devices under heavy radio traffic conditions on site.

1. Turn on the test sound source and adjust the sound volume in the checked room.
2. Outside the checked room:
 - connect the antenna and headphones to the main unit of ST 500 and turn it on
 - put on the headphones
3. Turn on SELECTIVE HF DETECTOR channel ("PANORAMA" Mode).
4. Depending on the activity in the frequency range, set the optimal gain, making sure that no off-scale occurs.
5. Activate the DIFFERENTIAL mode, obtaining a differential view.
6. Enter the room while monitoring the differential view; note any new signals that may appear, or increasing levels of the ones already detected.
7. If new signals have appeared, select the table row with the strongest one.
8. Activate "FIXED FREQUENCY ANALYSIS" function.
9. Analyze the detected signal as follows:
 - listen to the signal in headphones at different passband (1 or 20 MHz)
 - analyze the signal with the oscilloscope
 - if needed, use frequency fine tuning

Signs of "THREAT" signal:

- at the frequency of the detected signal, the test sound is heard through the headphones
 - the test sound is not heard in the headphones, but the oscilloscope picture of the demodulated signal changes with the test sound
 - there is a radical decrease in the level of the detected signal when ST 500 is brought outside the room.
10. Analyze all the other signals in a similar way.

9.1.3. SEARCH IN THE "WIRELESS COMMUNICATION" MODE

In the "WIRELESS COMMUNICATION" mode, the frequency bands that meet a specific digital communication standard and are used by eavesdropping devices are monitored. When searching for eavesdropping devices, three functions are used:

1. "Mobile devices monitoring" (3.4.1)
2. "Base stations monitoring" (3.4.2)
3. "User list" (3.4.3)

Factory settings of the "WIRELESS COMMUNICATION" mode:

MOBILE DEVICES	Frequency range, MHz	
CDMA450	453	458
GSM900	899.5	915
GSM1800	1710	1785
3G	1920	1980
3G low	2010	2025
DECT	1880	1900
Wi-Fi/BT	2400	2480
4G/LTE	2500	2700
Wi-Fi 5	5200	5800
BASE STATIONS	Frequency range, MHz	
CDMA450	463	468
GSM900	935	960
GSM1800	1805	1880
3G	2110	2170
3G low	2010	2025
DECT	1880	1900
USER LIST	Frequency range, MHz	
----	88	108
----	430	450

Using the ST 500 software, bands can be added to, or removed from the user list, as well as the lists of mobile device and base station frequencies, and band parameters can be adjusted.

The search procedure is the same for all functions of the "WIRELESS COMMUNICATION" mode:

1. In the checked room:
 - connect the antenna and headphones to the main unit of ST 500
 - turn on the test sound source and adjust the sound volume (only when using "USER LIST")
 - turn on ST 500
2. Activate "SELECTIVE HF DETECTOR" channel.
3. Depending on the activity in the frequency range, set the optimal gain, making sure that no off-scale occurs.
4. Turn on "WIRELESS COMMUNICATION" mode
5. Activate one of the functions ("Base stations monitoring", "Mobile devices monitoring", "User lists").

6. Monitor signal presence, watching the level bars in the table.
7. If radio traffic is detected in any band, it is necessary to investigate the observed signals. To do this, set the cursor to the desired band and activate the "ANALYSIS OF DETECTED SIGNALS" function.

Signs of "THREAT" signal while analyzing frequency bands used by digital mobile communications devices ("MOBILE DEVICES MONITORING" function):

- high levels of a detected digital signal (in the absence of legitimate mobile communications devices nearby)
- time-frequency structure of the signal different from the standard pattern (while analyzing with the oscilloscope)
- an analog signal detected, that correlates with the test sound

Signs of "THREAT" signal while analyzing the ranges of mobile telecoms base stations ("BASE STATIONS MONITORING" function):

- time-frequency structure of the signal different from the standard pattern (while analyzing with the oscilloscope)
- an analog signal detected, that correlates with the test sound

Signs of "THREAT" signal while analyzing the user list ("USER LIST" function):

- at the frequency of the detected signal, the test sound is heard through the headphones
- the test sound is not heard in the headphones, but the oscilloscope picture of the demodulated signal changes with the test sound
- there is a radical decrease in the level of the detected signal when ST 500 is brought outside the room

9.1.4. LOCALIZATION OF THE SOURCE OF DETECTED SIGNAL

If the eavesdropping device uses an open transmission channel, an **acoustic** or **energetic** method is used for localization. Localization of the source of the encoded signal is produced only by the **energy method**.

When using the **acoustic method**, the operator turns on the test sound source, moves it around the room (listening to the demodulated signal in the headphones) and searches for the place in the room where the signal is heard best.

For more accurate localization, it is recommended to knock lightly on interior items located near this place. A knock will be heard quite well in the headphones.

Energy method is to determine the place in the room where the signal level will be maximum. The analysis is performed using indicators that are implemented in various modes of the SELECTIVE HF DETECTOR:

- "PANORAMA" or DIFFERENTIAL mode, "FIXED FREQUENCY ANALYSIS" function (fig.12, 2)
- "AUTOMATED" mode table (fig.14, 4)
- "WIRELESS COMMUNICATION" mode, "ANALYZING DETECTED SIGNALS" function (fig.19, 13)

Having determined the place in the room where the signal level is maximum, it is necessary to use the "SET 0" function (3.2.2). This will allow to more accurately determine the location of the eavesdropping device.

When localizing a GSM signal source in an energetic way, difficulties may arise. The signal level in different places of the room will be approximately the same, and it is difficult to determine where the signal level is at its maximum.

Setting the minimum gain value will also not solve this problem. Localization is recommended with the antenna turned off. In most cases, this will allow to determine the installation location of the GSM device.

9.2. GUIDELINES FOR USE OF "IR DETECTOR" CHANNEL

The IR DETECTOR channel is intended for the detection and location of eavesdropping devices that send transmissions within the infrared range to a special IR receiver.

The operation range of such a system may be hundreds of meters, provided there is an **unobstructed line of view** between the IR transmitter and IR receiver. As a rule, the receiver will be outside the inspected room, with the IR transmitter inside and directly opposite a window.

Search for the eavesdropping device should begin from the window, while directing the IR-sensor (fig.2, 5) at the suspected location of the IR receiver.

Search algorithm:

1. Turn on the test sound source in the checked room.
2. Turn on ST 500 and activate IR DETECTOR.
3. Direct the IR sensor at the suspected location of the IR receiver.

Important! The detection range of the IR detector is 50-70 cm.

4. Observe the changes in the signal level on the indicator (fig.20, 2), the waveform shape (fig.20, 4) and the sound volume in the headphones.

An increase in the signal level should indicate that an active IR source is within the field of view of the IR sensor ($\pm 20^\circ$).

Signs of "THREAT" signal:

- High signal levels, test sound heard in the headphones
- High signal levels, test sound not heard in the headphones, oscilloscope picture typical for a digital signal

The signal is localized using the received signal level indicator (fig.20, 2). The IR signal source is set at the point where the signal level is at its maximum.

For more precision, use the DIFFERENTIAL mode.

9.2.1. SELECTION OF "FALSE" SIGNALS

When approaching a radio signal source (Wi-Fi router, DECT base, etc.), the received signal level may increase due to pickups on the instrument's input circuits. To select "false" and IR signals, close the IR sensor with your hand (fig.2, 5). A significant decrease of the signal level on the indicator (fig.20, 2) indicates that a signal in the IR range. When receiving a "false" signal, the level on the indicator does not change.

9.3. GUIDELINES FOR USE OF THE "WIRED RECEIVER" CHANNEL

The WIRED RECEIVER channel is intended for the detection of wired high-frequency transmitters in electric mains and low current circuits.

The range of information transmission via electric mains, as a rule, does not exceed 500 meters within one or several buildings, which are powered from one low-voltage bus of a transformer substation. When using telephone lines and LAN cables, the transmission distance may exceed 500 meters.

Method of connection to the circuit: parallel.

Power Supply: from the circuit, or from an autonomous source.

Search objects:

- Power mains lines
- Telephone lines
- LAN cabling
- Other low current lines, including those out of operation (with no end user devices connected) and/or illegitimately laid cabling

Auxiliary equipment:

- Adapter for connecting the main unit to electric mains ([fig.1, 2](#))
- Test sound source

To search for HF signals in electric mains and low current circuits, the "PANORAMA" (DIFFERENTIAL) and the AUTOMATED modes are used.

For the analysis of the detected signal, the "FIXED FREQUENCY ANALYSIS" function and OSCILLOSCOPE are used.

9.3.1. ELECTRIC MAINS TESTING

The initial state.

The electric mains are powered and it is possible to de-energize it. This line only supplies the checked room. It is suspected that high-frequency transmitters may be planted on the mains cabling or user devices connected to it, transferring data through the cabling outside the room.

Search algorithm:

1. De-energize the circuit.
2. Make sure there is no voltage on the electric mains branch in the room.
3. Disconnect all consumer devices from the mains (plug them out of the sockets).
4. Connect the electric mains adapter to the main unit, and to one of the electric sockets on the circuit.
5. Turn on ST 500 activate the "WIRED RECEIVER" channel.
6. Set "MAINS" in the circuit type selection menu.
7. Select the frequency range to scan (100 kHz – 60 MHz or 100 kHz – 180 MHz); all activity within the range will be shown, with the mains branch de-energized.
8. Turn on the attenuator ("F4").

When an electric mains circuit is being tested, the electronic switch automatically engages the pair of wires "1-2", which corresponds to the wiring scheme of the adaptor's plug. In the status bar the symbol  (electric mains mode) is shown.

On the screen, reception within the selected frequency band on deenergized line will be shown. With power cut off, no eavesdropping devices powered from the circuit will be working, so all the signals received at this time can be considered "non-threat" (interference, broadcast signals, etc.)

To exclude all those from the search, the DIFFERENTIAL mode should be used.

9. Turn on "DIFFERENTIAL MODE" ("F3").

A differential spectrum showing activity in the frequency band will appear on the screen. The levels of all previously received signals will be set as "0", and from this point on only new signals will be displayed.

10. Turn on the power switch on the electric switchboard.

If a high-frequency transmitter is connected to the circuit, it will be activated now that the power supply is back on, and signals from eavesdropping devices will be registered.

When new signals appear in the differential spectrum, turn on the AUTOMATED mode ("F2" - "Search"). A table listing the detected signals will appear, with the first table row selected (lowest signal frequency). It is recommended to sort the table by level.

11. Turn on the test sound source and adjust the sound volume.

12. Connect headphones ("PHONE" socket) and adjust the sound volume.

13. Analyze the demodulated signal alternating "AM"/"FM" ("F2").

14. If necessary, fine-tune the signal frequency.

15. If necessary, analyze the demodulated signal on the oscilloscope ("F3"); to return to the AUTOMATED mode table, press again "F3".

16. Select the next table row.

17. Repeat the research procedure, changing between AM/FM ("F2").

18. Test all the detected signals in a similar way.

The absence of new signals in differential spectrum upon turning power back on means that there are no active eavesdropping devices connected to the circuit. However, it should be noted that there may be malfunctioning or remotely controlled devices that are currently turned off or on standby. Such devices can be detected with instruments employing "active" search methods (nonlinear junction detectors and reflectometers).

Variants of possible changes in the differential spectrum when the power supply is turned on and the reasons for its occurrence:

- New signals were detected, in the analysis of which it was possible to hear the reference sound. This means that an analog HF transmitter installed in the room is operating in the tested line.
- New signals were detected, the analysis of which failed to hear the reference sound. The line may have a digital (or coded) HF transmitter.
- A significant increase in background levels is observed in the frequency range 10–100 MHz. This may be caused by the operation of a PLC modem.

If "THREAT" signals were not detected, check the changes in the differential spectrum when the consumers are connected.

It is required to receive a differential panorama of the powered line, and then in turn connect consumers. Thus, it is possible to establish which consumer is the source of the "THREAT" signal.

19. Exit the AUTOMATED mode ("ESC"); the current differential spectrum on the powered circuit with no consumer connections will be shown.

20. Exit the DIFFERENTIAL mode ("F3"); the current differential spectrum on the powered circuit with no consumer connections will be shown.

21. Turn on the DIFFERENTIAL mode ("F3"); the differential spectrum on the powered circuit will be shown, with all the previously detected signals set as "0".

22. Connect one of the consumer devices to the circuit. If new signals are detected in the "PANORAMA" mode, turn on the AUTOMATED mode ("F2") and analyze each of them as described earlier in this manual.

Upon analyzing all the signals, exit the AUTOMATED mode ("ESC"), turn off DIFFERENTIAL mode ("F3") and then turn it back on to obtain a new differential spectrum.

Connect the next consumer device to the circuit and analyze the new signals, following the above procedure.

The analysis is complete when the circuit has been tested with all the consumer devices connected consecutively. The consumer devices whose connection lead to the appearance of "THREAT" signals in the differential spectrum, must be disassembled and checked for non-standard components.

9.3.2. LOW CURRENT CIRCUIT TESTING

In contrast to power two-core cabling, low current cabling is, as a rule, multi-core, and the operator must test all the possible paired combinations of wires.

A testing procedure for an office PBX line is described below.

The initial state:

Office PBX is connected to the telephone line. The telephone is connected to the line through a telephone socket (the telephone receiver is "hung up"). The telephone line is powered from the PBX and is operating normally.

The HF transmitter can be connected to a telephone line laid in the room, or installed in the telephone.

Analog telephone line search algorithm:

1. Connect ST 500 to the telephone line ([fig.25](#) and [fig.26](#)).
2. Turn on the test sound source and adjust the sound volume.
3. Connect headphones to the main unit.
4. Turn on ST 500 and activate "WIRED RECEIVER" channel.
5. Select circuit type ("Low Voltage").
6. Select one of the frequency bands.
7. The table of combinations of pairs will be display on the screen.
8. Press "FUNC" (turn on "ELECTRONIC SWITCH SETTINGS" mode).
9. Press "F3" (turn on 6P4C connecting); the connection scheme is shown in [Supplement #2](#)

When a four-wire telephone line cable is connected, the switch contacts with numbers 3, 4, 5, 6 will be used. Wire combinations 3-4, 3-5, 3-6, 4-5, 4-6, 5-6 should be checked.

It is necessary to take into account that the transmitter can be powered normally (from the involved "4-5" pair), and transmit information through another pair.

10. In the table set the cursor on the line corresponding to the pair "3-4". The cell displays the voltage value in the connected pair. During normal operation of the telephone line, there is no voltage on this pair.

11. Press "ENTER". Activity in the frequency band on the pair "3-4" will be shown.

12. If necessary, turn on the attenuator ("F4").

13. Activate the AUTOMATED mode ("F2").

14. Listen to all detected signals by switching AM/FM demodulation ("F2").

15. Exit the AUTOMATED mode ("ESC") to the "PANORAMA" mode.

16. Activate the "ELECTRONIC SWITCH CONTROL" mode ("F1").

17. Set the table cursor to the next pair of wires, press "ENTER".

18. Test all the remaining paired combinations, as described above in 10-16.

Listening to test sound source means that there is a working analog wired HF transmitter connected to the telephone line in the room.

In this case, staying on the combination in which the "threat" signal was detected should disconnect the telephone set from the line. If this signal disappears, then its source is in the telephone.

If the signal is not lost when the telephone is disconnected, then its source is connected to the telephone line.

9.4. GUIDELINES FOR USE OF THE "LOW FREQUENCY AMPLIFIER" CHANNEL

The **LOW FREQUENCY AMPLIFIER** channel is intended for the detection of transmission channels utilized by dynamic and electret wired microphones, transmitting within the speech frequency band over low current lines.

Dynamic microphones are the most common type of microphones that do not require power supply and do not utilize a pre-amplifier. The transmissions are made over two wires (which can be cores in a multi-core cable). The transmission range can be hundreds of meters.

Electret microphones are a variety of capacitor microphones that are also quite common in eavesdropping equipment due to their low cost and ability to operate in rugged conditions.

Their design requires a pre-amplifier, for whose operation DC voltage of certain polarity is needed. This can be achieved by creating "phantom" power supply on the microphone, by simultaneous transmission of information signals over the feeding wires. Also, some electret microphones are equipped with independent power supply source.

Method of connecting to the circuit: parallel

Power Supply: 3 ÷ 20 V

Tested circuits:

- Telephone lines
- LAN cabling
- Other low current lines, including those out of operation (with no end user devices connected) and/or illegitimately laid cabling

Auxiliary equipment: test sound source

9.4.1. SEARCH FOR ACTIVE MICROPHONES IN AN ANALOG TELEPHONE LINE

The initial state:

1. The tested telephone line consists of 4 wires.
2. The cable is equipped with a 6P4C plug.
3. The consumer device is an analog telephone.
4. The two central connector pins are used by the telephone.
5. PBX' operation voltage is 26 V.
6. The line operates normally, with the telephone connected to it.

Search algorithm:

1. Connect ST 500 to the telephone line according to the scheme 3B (fig.25) or 3D,3E (fig.26).
2. Turn on the test sound source.
3. Turn on the ST 500, activate "LOW FREQUENCY AMPLIFIER" channel.
4. Press "FUNC" (turn on "ELECTRONIC SWITCH SETTINGS" mode).
5. Press "F3" to select 6P4C connection, The scheme is shown in [Supplement #2](#).
6. Press "FUNC" (turn off "ELECTRONIC SWITCH SETTINGS" mode).
7. Press "F2" and set maximum gain (x100).
8. Connect the headphones to the main unit and adjust the sound volume.
9. Press "F4" (turn on the AUTOMATED mode).

The device will start iterating through all possible combinations of wire pairs. The tabular cursor moves through the table, stopping for a few seconds on the tested combination of wire pairs. At this time, the operator can listen to the received signal. After going through all the possible combinations, the scan will stop.

Possible testing results and their interpretation:

Case 1

Pair 3-6	There is no voltage. The test sound cannot be heard in the audio output.	No dynamic microphone is detected. An electret microphone may still be connected, that had no power supply at the time of testing. A bias voltage checks (9.4.2) is required.
Pair 4-5	The voltage is DC 26 V. The test sound cannot be heard in the audio output.	

Case 2

Pair 3-6	There is no voltage. The test sound can be heard in the audio output.	Either a dynamic microphone, or an electret microphone with independent power supply (possibly, from the telephone line) is connected. The microphone must be located.
Pair 4-5	The voltage DC 26 V. The test sound cannot be heard in the audio output.	

Case 3

Pair 3-6	The voltage is DC 3-20 V. The test sound can be heard in the audio output.	An electret microphone is connected, with "phantom" power supply through wires #3 and #6. The microphone must be located.
Pair 4-5	The voltage DC 26 V. The test sound cannot be heard in the audio output.	

Case 4

Pair 3-6	There is no voltage. The test sound cannot be heard in the audio output.	An electret microphone is connected, with "phantom" power supply from the telephone line and signal transmission over wires #4 and #5. The microphone must be located.
Pair 4-5	The voltage DC 26 V. The test sound can be heard in the audio output.	

Microphone localization algorithm is described in 9.5.

9.4.2. ACTIVATION OF ELECTRET MICROPHONES IN AN ANALOG TELEPHONE LINE

In order to detect an electret microphone having no power supply, bias voltage must be applied to the circuit.

The initial state - the connection scheme, circuit type, and pin numbers are the same as described in 9.4.1.

Search algorithm:

1. Disconnect the circuit(branch) from the PBX.
2. Turn on the test sound source in the room.
3. Set the gain at 0 dB.
4. Set the bias voltage +30 V.
5. Activate the AUTOMATED mode ("F4").

The device will start going through all the possible paired combinations, pausing at each table line while the corresponding pair of cores is being tested; in the meantime, the operator can listen to the received signal.

If the sound from the test sound source can be heard in the headphones, it means an electret microphone is detected, and it will be necessary to locate it.

After all the combinations have been tested, scanning will stop.

If the test sound has not been heard in the headphones, search should be repeated in the AUTOMATED mode, with reversed bias voltage (-30 V).

Recommendations:

- If the test sound can be heard during testing, it is probable that the microphone is planted in the telephone set. To make sure, disconnect the telephone; if the test sound can no longer be heard, the eavesdropping device is in the telephone.
- Any detected signals that have no relation to the test sound should be analyzed with oscilloscope or spectrum analyzer.

9.5. LOCALIZATION OF THE SIGNAL SOURCE DETECTED BY THE "WIRED RECEIVER" OR "LOW FREQUENCY AMPLIFIER" CHANNEL**9.5.1. ACOUSTIC METHOD**

The acoustic localization method is applied only when an **"open transmission channel"** of the eavesdropping device is detected. To implement the method, two operators are required. One of them moves the test sound source around the room, the other operator controls the level of the received signal using the ST 500.

Actions with the test sound source:

1. Turn on the test sound source.
2. Decrease the sound volume.
3. Carry the test sound source slowly around the room.

ST 500 operator procedure:

1. Activate "LFA" or "WR" (in whichever the transmission channel has been detected).
2. Connect the headphones, and listen to the sound background in the room.
2. Select the wire pair at which the test sound is audible
3. Find the spot where the test sound is the loudest

9.5.2. LOCALIZATION WITH ST 500 AND NONLINEAR JUNCTION DETECTOR (NLJD)

This method can only be used to locate **devices that incorporate electronic parts**. The procedure requires two people, one going the length of the cabling while pointing the active non-linear junction detector's antenna at it, and the other monitoring with ST 500 any response to the NLJD's irradiation from the cable.

Any electronics that are close to the cabling but not connected to it, in the proximity of the antenna will yield responses on the 2nd and 3rd harmonics; this will be registered by the non-linear locator operator, but not the operator of ST 500.

However, if the operator of ST 500 hears a typical signal from the NLJD through the headphones, this will mean that the NLJD's antenna is being pointed at an eavesdropping device directly connected to the circuit.

This method is most effective when using NLJD ST 402 "CAYMAN" in the "SEARCH" mode.

NLJD operator procedure:

1. Disconnect all consumer devices from the cabling.
2. Turn on "CAYMAN" NLJD and set it to "SEARCH".
3. Connect the headphones or minimize the volume of the built-in speaker.
4. Move along the cable while pointing the NLJD's antenna at it.

ST 500 operator procedure:



1. Connect ST 500 to the circuit.
2. Turn on ST 500.
3. Activate the channel ("LFA" or "WR") in which the suspect signal was detected.
4. In the table, select the wire pair at which the suspect signal was detected.
5. Connect the headphones.
6. Listen for a typical signal from the NLJD.

10. SUPPLEMENT #1. FUNCTIONS OF THE CONTROLS.



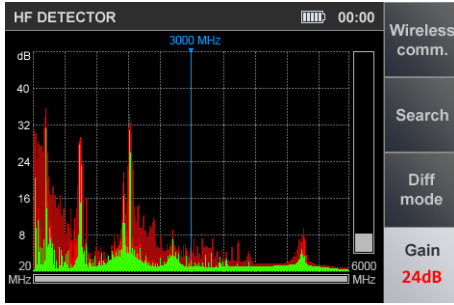

10.1. BASIC SETTINGS

MAIN MENU (CHANNEL SELECTION)			
	F1 enable SELECTIVE HF DETECTOR channel F2 enable IR DETECTOR channel F3 enable WIRED RECEIVER channel F4 enable LOW FREQUENCY AMPLIFIER channel navigate ENTER confirmation of action entering the SETTINGS mode - place the cursor on the corresponding menu item and press ENTER		
	SETTING THE DATE		
		navigate change value ENTER save and exit ESC exit without saving	
		SETTING THE TIME	
			navigate change value ENTER save and exit ESC exit without saving

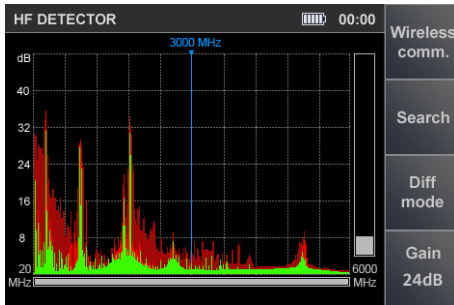

10.2. SELECTIVE HF DETECTOR



GAIN ADJUSTMENT	
	 increase gain
	 decrease gain
	F4 ENTER deactivate Gain adjustment
	MODE go to main menu of device
	ESC FUNC F1-F3 disabled

"PANORAMA" (DIFFERENTIAL) mode

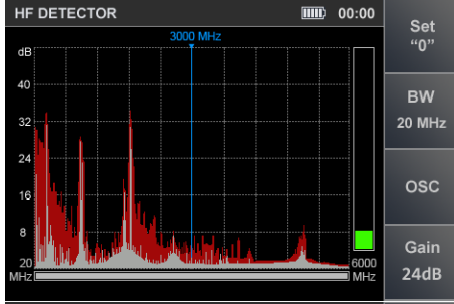

"PANORAMA" (DIFFERENTIAL) mode	
	ESC or MODE go to main menu of device
	 scaling (Zoom +)
	 scaling (Zoom -)
	scaling occurs relative to the set frequency (at cursor position).
	 frequency tuning
	F1 activate " WIRELESS COMMUNICATION " mode
	F2 activate AUTOMATED mode
	F3 activate/deactivate DIFFERENTIAL mode
	F4 activate Gain Setting
	ENTER turn on " FIXED FREQUENCY ANALYSIS " function
FUNC disabled	

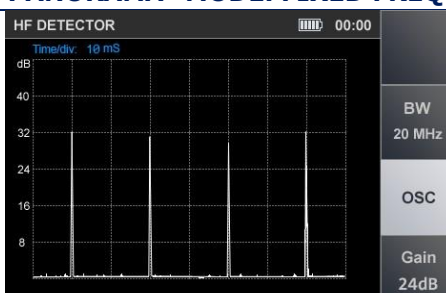

"PANORAMA" (DIFFERENTIAL) mode. "FIXED FREQUENCY ANALYSIS" function

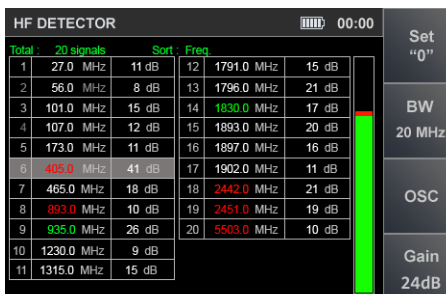

	MODE go to main menu of device
	ESC or ENTER turn off (step back)
	 cursor positioning (frequency tuning)
	F1 turn on/off " SET 0 "
	F2 select passband (1 or 20 MHz)
	F3 activate OSCILLOSCOPE
	F4 activate Gain Setting
 FUNC disabled	

"PANORAMA" MODE. FIXED FREQUENCY ANALYSIS, OSCILLOSCOPE		
	MODE	go to main menu of device
	ESC F3	turn off OSCILLOSCOPE
		time-axis zoom
	F2	select passband (1 or 20 MHz)
	F4	activate Gain Setting
	ENTER 	disabled
	FUNC	

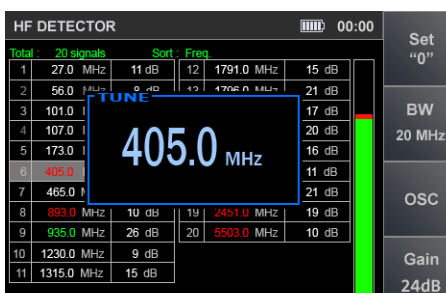
AUTOMATED mode

AUTOMATED mode, main table		
	MODE	go to main menu of device
	ESC	return to the previous mode
	FUNC	sort table (by ascending frequency or signal level)
	ENTER	activate " FREQUENCY TUNING " function
		navigate
		
	F1	turn on/off " SET '0' "
	F2	select passband (1 or 20 MHz)
	F3	activate OSCILLOSCOPE
	F4	activate Gain Setting

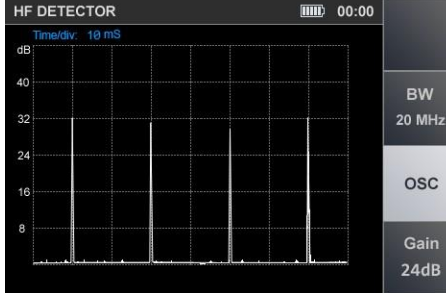

AUTOMATED mode, "FREQUENCY TUNING" function		
	MODE	go to main menu of device
	ESC and ENTER	turn off " FREQUENCY TUNING " function
		frequency tuning (with 0.2 MHz increment)
	F1	turn on/off " SET '0' "
	F2	select passband (1 or 20 MHz)
	F3	OSCILLOSCOPE activation
	F4	activate Gain Setting
	FUNC 	disabled

AUTOMATED mode, OSCILLOSCOPE		
	MODE	go to main menu of device
	ESC and F3	turn off OSCILLOSCOPE
		time-axis zoom
	F2	select passband (1 or 20 MHz)
	F4	activate Gain Setting
	ENTER 	disabled
	FUNC	

"WIRELESS COMMUNICATION" MODE



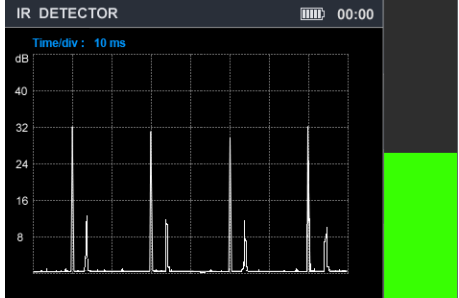



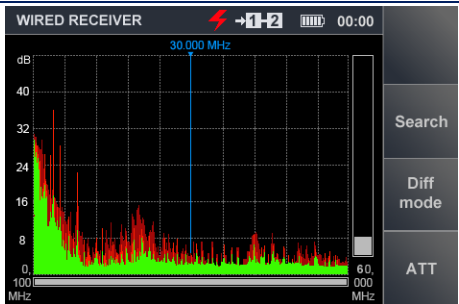

"MOBILE DEVICES MONITORING" function																	
	<table border="1"> <tr> <td>MODE</td> <td>go to main menu of device</td> </tr> <tr> <td>ESC</td> <td>go to "PANORAMA"</td> </tr> <tr> <td></td> <td>navigate</td> </tr> <tr> <td>ENTER</td> <td>turn on "ANALYZING DETECTED SIGNALS"</td> </tr> <tr> <td>F2</td> <td>turn on "BASE STATION MONITORING"</td> </tr> <tr> <td>F3</td> <td>turn on "USER LIST"</td> </tr> <tr> <td>F4</td> <td>activate Gain Setting</td> </tr> <tr> <td>F1, FUNC </td> <td>disabled</td> </tr> </table>	MODE	go to main menu of device	ESC	go to "PANORAMA"		navigate	ENTER	turn on "ANALYZING DETECTED SIGNALS"	F2	turn on "BASE STATION MONITORING"	F3	turn on "USER LIST"	F4	activate Gain Setting	F1, FUNC 	disabled
	MODE	go to main menu of device															
	ESC	go to "PANORAMA"															
		navigate															
	ENTER	turn on "ANALYZING DETECTED SIGNALS"															
	F2	turn on "BASE STATION MONITORING"															
F3	turn on "USER LIST"																
F4	activate Gain Setting																
F1, FUNC 	disabled																
"BASE STATIONS MONITORING" function																	
	<table border="1"> <tr> <td>MODE</td> <td>go to main menu of device</td> </tr> <tr> <td>ESC</td> <td>go to the previous mode (step back)</td> </tr> <tr> <td></td> <td>navigate</td> </tr> <tr> <td>ENTER</td> <td>turn on "ANALYZING DETECTED SIGNALS"</td> </tr> <tr> <td>F1</td> <td>turn on "MOBILE DEVICES MONITORING "</td> </tr> <tr> <td>F3</td> <td>turn on "USER LIST"</td> </tr> <tr> <td>F4</td> <td>activate Gain Setting</td> </tr> <tr> <td>F2, FUNC </td> <td>disabled</td> </tr> </table>	MODE	go to main menu of device	ESC	go to the previous mode (step back)		navigate	ENTER	turn on "ANALYZING DETECTED SIGNALS"	F1	turn on "MOBILE DEVICES MONITORING "	F3	turn on "USER LIST"	F4	activate Gain Setting	F2, FUNC 	disabled
	MODE	go to main menu of device															
	ESC	go to the previous mode (step back)															
		navigate															
	ENTER	turn on "ANALYZING DETECTED SIGNALS"															
	F1	turn on "MOBILE DEVICES MONITORING "															
F3	turn on "USER LIST"																
F4	activate Gain Setting																
F2, FUNC 	disabled																
"USER LIST" function																	
	<table border="1"> <tr> <td>MODE</td> <td>go to main menu of device</td> </tr> <tr> <td>ESC</td> <td>go to the previous mode (step back)</td> </tr> <tr> <td></td> <td>navigate</td> </tr> <tr> <td>ENTER</td> <td>turn on "ANALYZING DETECTED SIGNALS"</td> </tr> <tr> <td>F1</td> <td>turn on " MOBILE DEVICES MONITORING"</td> </tr> <tr> <td>F2</td> <td>turn on "BASE STATIONS MONITORING"</td> </tr> <tr> <td>F4</td> <td>activate Gain Setting</td> </tr> <tr> <td>F1, FUNC </td> <td>disabled</td> </tr> </table>	MODE	go to main menu of device	ESC	go to the previous mode (step back)		navigate	ENTER	turn on "ANALYZING DETECTED SIGNALS"	F1	turn on " MOBILE DEVICES MONITORING"	F2	turn on "BASE STATIONS MONITORING"	F4	activate Gain Setting	F1, FUNC 	disabled
	MODE	go to main menu of device															
	ESC	go to the previous mode (step back)															
		navigate															
	ENTER	turn on "ANALYZING DETECTED SIGNALS"															
	F1	turn on " MOBILE DEVICES MONITORING"															
F2	turn on "BASE STATIONS MONITORING"																
F4	activate Gain Setting																
F1, FUNC 	disabled																
"ANALYZING DETECTED SIGNALS", OSCILLOSCOPE																	
	<table border="1"> <tr> <td>MODE</td> <td>go to main menu of device</td> </tr> <tr> <td>ESC</td> <td>go to the previous mode (step back)</td> </tr> <tr> <td></td> <td>switch to SPECTRUM ANALYZER</td> </tr> <tr> <td>ENTER</td> <td>turn on/off "SET "0"</td> </tr> <tr> <td></td> <td>time-axis zoom</td> </tr> <tr> <td>F1-F4 FUNC</td> <td>disabled</td> </tr> </table>	MODE	go to main menu of device	ESC	go to the previous mode (step back)		switch to SPECTRUM ANALYZER	ENTER	turn on/off "SET "0"		time-axis zoom	F1-F4 FUNC	disabled				
	MODE	go to main menu of device															
	ESC	go to the previous mode (step back)															
		switch to SPECTRUM ANALYZER															
	ENTER	turn on/off "SET "0"															
		time-axis zoom															
F1-F4 FUNC	disabled																
"ANALYZING DETECTED SIGNALS", SPECTRUM ANALYZER																	
	<table border="1"> <tr> <td>MODE</td> <td>go to main menu of device</td> </tr> <tr> <td>ESC</td> <td>exit to the previous mode (step back)</td> </tr> <tr> <td></td> <td>switch to OSCILLOSCOPE</td> </tr> <tr> <td>ENTER</td> <td>turn on/off "SET "0"</td> </tr> <tr> <td></td> <td>setting frequency</td> </tr> <tr> <td>F1-F4 FUNC</td> <td>disabled</td> </tr> </table>	MODE	go to main menu of device	ESC	exit to the previous mode (step back)		switch to OSCILLOSCOPE	ENTER	turn on/off "SET "0"		setting frequency	F1-F4 FUNC	disabled				
	MODE	go to main menu of device															
	ESC	exit to the previous mode (step back)															
		switch to OSCILLOSCOPE															
	ENTER	turn on/off "SET "0"															
		setting frequency															
F1-F4 FUNC	disabled																

10.3. IR DETECTOR

	MODE ESC	go to main menu of device
	ENTER	activate /deactivate DIFFERENTIAL mode
		time-axis zoom
	F1-F4 FUNC 	disabled

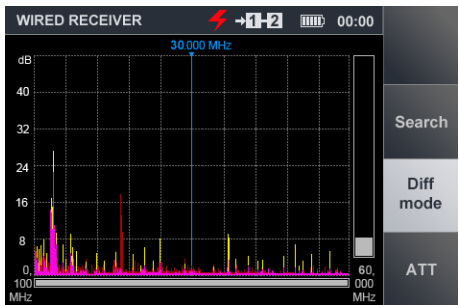
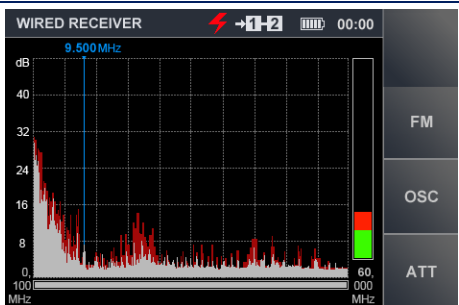
10.4. WIRED RECEIVER

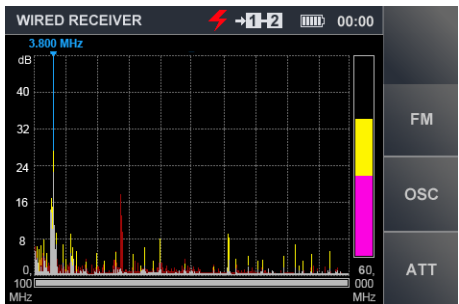
ELECTRIC MAINS TESTING

"PANORAMA" (DIFFERENTIAL mode)			
	ESC or MODE	go to main menu of device	
		scaling (Zoom +) ¹	
		scaling (Zoom -) ¹	
		cursor positioning	
	ENTER	turn on " FIXED FREQUENCY ANALYSIS "	
	F2	activate the AUTOMATED mode	
	F3	activate/deactivate DIFFERENTIAL mode	
	F4	activate/deactivate Attenuator	
	F1 FUNC	disabled	
	¹ - the scaling is centered on the selected frequency (at cursor position)		
"PANORAMA" (DIFFERENTIAL mode) FIXED FREQUENCY ANALYSIS function			
	MODE	go to main menu of device	
	ESC or ENTER	turn off (step back)	
	F2	toggle modulation (FM/AM)	
	F3	turn on OSCILLOSCOPE	
	F4	activate/deactivate Attenuator	
		cursor positioning (frequency tuning)	
		F1 FUNC 	disabled









OSCILLOSCOPE (when activated from the "PANORAMA" mode)		
	MODE	go to main menu of device
	F3 ESC	turn off OSCILLOSCOPE
	F2	toggle modulation (FM/AM)
	F4	activate/deactivate Attenuator
		time-axis zoom
	F1 FUNC 	disabled

AUTOMATED mode		
	MODE	go to main menu of device
	ESC	return to the previous mode
	FUNC	sort the table (by ascending frequency or signal level)
	ENTER	turn on " FREQUENCY TUNING " function
		navigate
	F2	toggle modulation (FM/AM)
	F3	OSCILLOSCOPE activation
	F4	activate/deactivate Attenuator
	F1	disabled

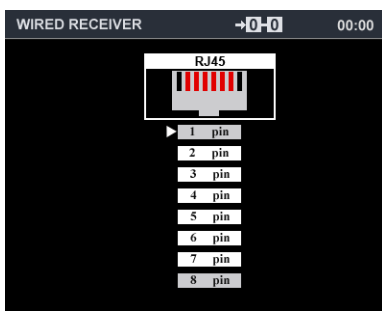
"FREQUENCY TUNING" function		
	MODE	go to main menu of device
	ENTER ESC	exit " FREQUENCY TUNING " function
		frequency tuning (with 10 kHz increment)
	F2	toggle modulation (FM/AM)
	F3	turn on OSCILLOSCOPE
	F4	turn on/off Attenuator
	FUNC F1 	disabled

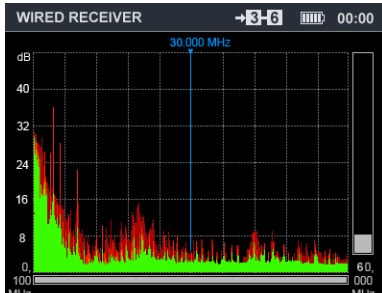
OSCILLOSCOPE (when activated from the AUTOMATED mode)		
	MODE	go to main menu of device
	F3 ESC	turn off OSCILLOSCOPE
	F2	toggle modulation (FM/AM)
	F4	turn on/off Attenuator
		time-axis zoom
	F1 FUNC 	disabled

LOW CURRENT CIRCUIT TESTING

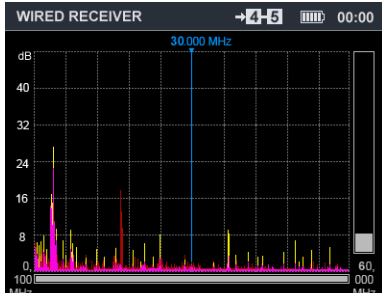
"ELECTRONIC SWITCH CONTROL" mode			
		MODE ESC 	go to main menu of device navigate
		ENTER	activate "PANORAMA" mode
		FUNC	activate "ELECTRONIC SWITCH SETTINGS" mode
		F1-F4	disabled
"ELECTRONIC SWITCH SETTINGS" mode			
		ESC FUNC F1 F2 F3 F4  ENTER  MODE	deactivate "ELECTRONIC SWITCH SETTINGS" mode select/deselect the 8P8C standard scheme select/deselect the 6P6C standard scheme select/deselect the 6P4C standard scheme select/deselect the 6P2C standard scheme choose pin number (when setting manually) select/deselect pin (when setting manually) disabled
"PANORAMA" (DIFFERENTIAL mode)			
		MODE   	go to main menu of device scaling (Zoom +) scaling (Zoom -) cursor positioning
		ENTER	turn on "FIXED FREQUENCY ANALYSIS" function
		F1 ESC	go to "ELECTRONIC SWITCH CONTROL" mode
		F2	activate the AUTOMATED mode
		F3	activate/deactivate DIFFERENTIAL mode
		F4	turn on/off Attenuator
		FUNC	disabled
		1 - the scaling is centered on the selected frequency (at cursor position)	

"PANORAMA" (DIFFERENTIAL mode). "FIXED FREQUENCY ANALYSIS" function																			
	<table border="1"> <tr> <td>MODE</td> <td>go to main menu of device</td> </tr> <tr> <td>ESC ENTER</td> <td>turn off "FIXED FREQUENCY ANALYSIS" function</td> </tr> <tr> <td>F2</td> <td>toggle modulation (FM/AM)</td> </tr> <tr> <td>F3</td> <td>turn on OSCILLOSCOPE</td> </tr> <tr> <td>F4</td> <td>turn on/off Attenuator</td> </tr> <tr> <td>↔</td> <td>cursor positioning (frequency tuning)</td> </tr> <tr> <td>F1 FUNC ↑ ↓</td> <td>disabled</td> </tr> </table>	MODE	go to main menu of device	ESC ENTER	turn off "FIXED FREQUENCY ANALYSIS" function	F2	toggle modulation (FM/AM)	F3	turn on OSCILLOSCOPE	F4	turn on/off Attenuator	↔	cursor positioning (frequency tuning)	F1 FUNC ↑ ↓	disabled				
	MODE	go to main menu of device																	
ESC ENTER	turn off "FIXED FREQUENCY ANALYSIS" function																		
F2	toggle modulation (FM/AM)																		
F3	turn on OSCILLOSCOPE																		
F4	turn on/off Attenuator																		
↔	cursor positioning (frequency tuning)																		
F1 FUNC ↑ ↓	disabled																		
	<table border="1"> <tr> <td>MODE</td> <td>go to main menu of device</td> </tr> <tr> <td>F3, ESC</td> <td>turn off OSCILLOSCOPE</td> </tr> <tr> <td>F2</td> <td>toggle modulation (FM/AM)</td> </tr> <tr> <td>F4</td> <td>turn on/off Attenuator</td> </tr> <tr> <td>↔</td> <td>time-axis zoom</td> </tr> <tr> <td>F1 FUNC ↑ ↓</td> <td>disabled</td> </tr> </table>	MODE	go to main menu of device	F3, ESC	turn off OSCILLOSCOPE	F2	toggle modulation (FM/AM)	F4	turn on/off Attenuator	↔	time-axis zoom	F1 FUNC ↑ ↓	disabled						
	MODE	go to main menu of device																	
F3, ESC	turn off OSCILLOSCOPE																		
F2	toggle modulation (FM/AM)																		
F4	turn on/off Attenuator																		
↔	time-axis zoom																		
F1 FUNC ↑ ↓	disabled																		
OSCILLOSCOPE (when activated from the "PANORAMA" mode)																			
	<table border="1"> <tr> <td>MODE</td> <td>go to main menu of device</td> </tr> <tr> <td>F3, ESC</td> <td>turn off OSCILLOSCOPE</td> </tr> <tr> <td>F2</td> <td>toggle modulation (FM/AM)</td> </tr> <tr> <td>F4</td> <td>turn on/off Attenuator</td> </tr> <tr> <td>↔</td> <td>time-axis zoom</td> </tr> <tr> <td>F1 FUNC ↑ ↓</td> <td>disabled</td> </tr> </table>	MODE	go to main menu of device	F3, ESC	turn off OSCILLOSCOPE	F2	toggle modulation (FM/AM)	F4	turn on/off Attenuator	↔	time-axis zoom	F1 FUNC ↑ ↓	disabled						
	MODE	go to main menu of device																	
F3, ESC	turn off OSCILLOSCOPE																		
F2	toggle modulation (FM/AM)																		
F4	turn on/off Attenuator																		
↔	time-axis zoom																		
F1 FUNC ↑ ↓	disabled																		
AUTOMATED mode																			
	<table border="1"> <tr> <td>MODE</td> <td>go to main menu of device</td> </tr> <tr> <td>ESC</td> <td>return to the previous mode¹</td> </tr> <tr> <td>FUNC</td> <td>sort the table (by ascending frequency or signal level)</td> </tr> <tr> <td>ENTER</td> <td>turn on "FREQUENCY TUNING" function</td> </tr> <tr> <td>↔ ↑ ↓</td> <td>table row selection</td> </tr> <tr> <td>F1</td> <td>go to "ELECTRONIC SWITCH CONTROL"</td> </tr> <tr> <td>F2</td> <td>toggle modulation (FM/AM)</td> </tr> <tr> <td>F3</td> <td>turn on OSCILLOSCOPE</td> </tr> <tr> <td>F4</td> <td>turn on/off Attenuator</td> </tr> </table>	MODE	go to main menu of device	ESC	return to the previous mode ¹	FUNC	sort the table (by ascending frequency or signal level)	ENTER	turn on "FREQUENCY TUNING" function	↔ ↑ ↓	table row selection	F1	go to "ELECTRONIC SWITCH CONTROL"	F2	toggle modulation (FM/AM)	F3	turn on OSCILLOSCOPE	F4	turn on/off Attenuator
	MODE	go to main menu of device																	
ESC	return to the previous mode ¹																		
FUNC	sort the table (by ascending frequency or signal level)																		
ENTER	turn on "FREQUENCY TUNING" function																		
↔ ↑ ↓	table row selection																		
F1	go to "ELECTRONIC SWITCH CONTROL"																		
F2	toggle modulation (FM/AM)																		
F3	turn on OSCILLOSCOPE																		
F4	turn on/off Attenuator																		
	<p>¹ - returns to the DIFFERENTIAL mode, if the AUTOMATED mode was activated from the DIFFERENTIAL mode</p>																		

"FREQUENCY TUNING" function		
	MODE ENTER ESC	go to main menu of device turn off "FREQUENCY TUNING" function
	↕↕	adjust frequency
	F2	toggle modulation (FM/AM)
	F3	turn on OSCILLOSCOPE
	F4	turn on/off Attenuator
	FUNC F1	disabled
	⬆️⬆️	
OSCILLOSCOPE (when activated from the AUTOMATED mode)		
	MODE F3, ESC	go to main menu of device turn off OSCILLOSCOPE
	F2	toggle modulation (FM/AM)
	F4	turn on/off Attenuator
	↕↕	time-axis zoom
	F1 FUNC	disabled
	⬆️⬆️	

10.5. LOW FREQUENCY AMPLIFIER

"ELECTRONIC SWITCH CONTROL" mode		
	MODE ESC	go to main menu of device
	↕↕	navigate
	⬆️⬆️	
	ENTER F1	turn on OSCILLOSCOPE
	FUNC	activate "ELECTRONIC SWITCH SETTINGS" mode
	F2	activate Gain Setting
	F3	activate Bias Voltage Control
F4	activate AUTOMATED mode	
"ELECTRONIC SWITCH SETTINGS" mode		
	ESC FUNC	deactivate "ELECTRONIC SWITCH SETTINGS" mode
	F1	select/deselect the standard scheme 8P8C
	F2	select/deselect the standard scheme 6P6C
	F3	select/deselect the standard scheme 6P4C
	F4	select/deselect the standard scheme 6P2C
	⬆️⬆️	choose pin number (when setting manually)
	ENTER	select/deselect pin (when setting manually)
↕↕	disabled	
MODE		

GAIN SETTING			
			MODE go to the main menu of device F2 deactivate GAIN SETTING F3 activate Setting the Bias Voltage Gain + Gain - ENTER set minimum gain (x1) ESC FUNC F1 F4 disabled
BIAS VOLTAGE CONTROL			
			MODE go to main menu of device F3 deactivate Bias Voltage Control F2 activate Gain Setting setting the Bias Voltage +30 V setting the Bias Voltage -30 V ENTER setting the Bias Voltage 0 V FUNC ESC disabled F1 F4
OSCILLOSCOPE			
			MODE go to main menu of device F1 ESC go to " ELECTRONIC SWITCH CONTROL " mode F2 activate Gain Setting F3 activate Bias Voltage Control F4 turn on SPECTRUM ANALYZER vertical zoom of the OSCILLOSCOPE horizontal zoom of the OSCILLOSCOPE ENTER FUNC disabled
SPECTRUM ANALYZER			
			MODE go to main menu of device F1 ESC go to " ELECTRONIC SWITCH CONTROL " mode F2 activate Gain Setting F3 activate Bias Voltage Control F4 turn on OSCILLOSCOPE cursor positioning ENTER FUNC disabled

11. SUPPLEMENT #2. TYPICAL SETTINGS OF THE ELECTRONIC SWITCH.

8C8P connecting ("F1")

Computer 8-wire line equipped RJ45 connector

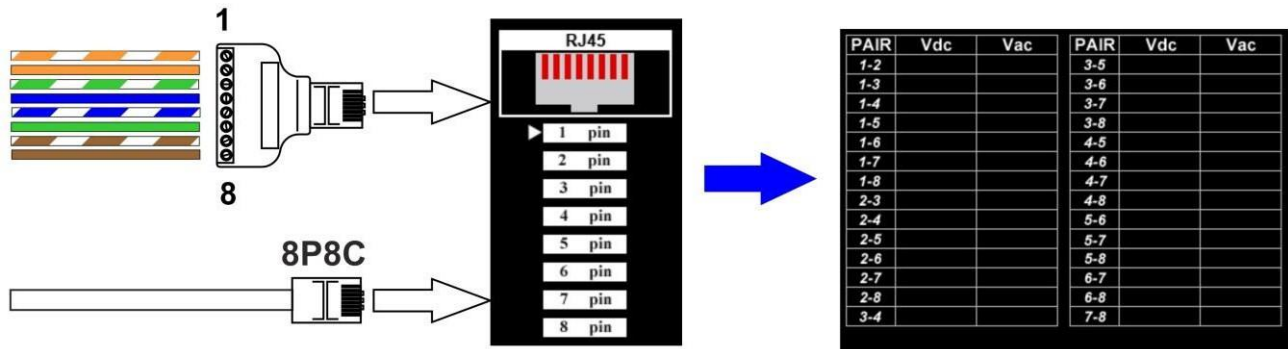

6P6C connecting ("F2")

6-wire telephone line, equipped with connector RJ25 or RJ12

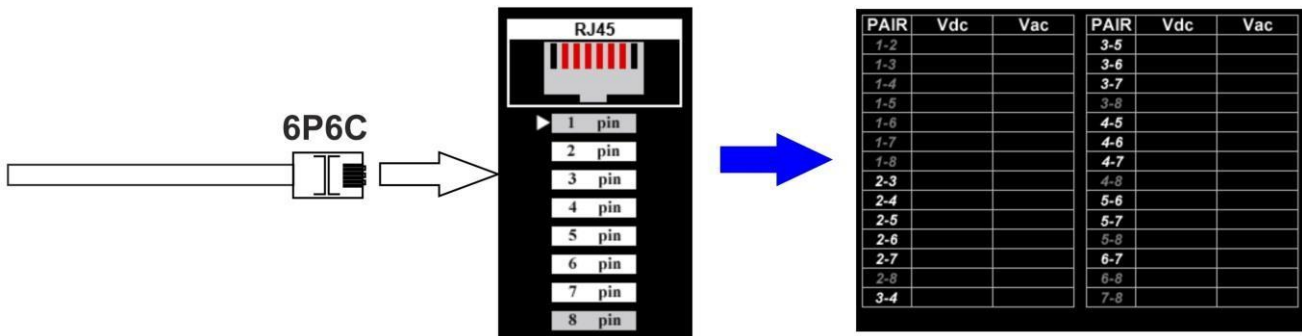

6P4C connecting ("F3")

4-wire telephone line (equipped with connectors RJ11)

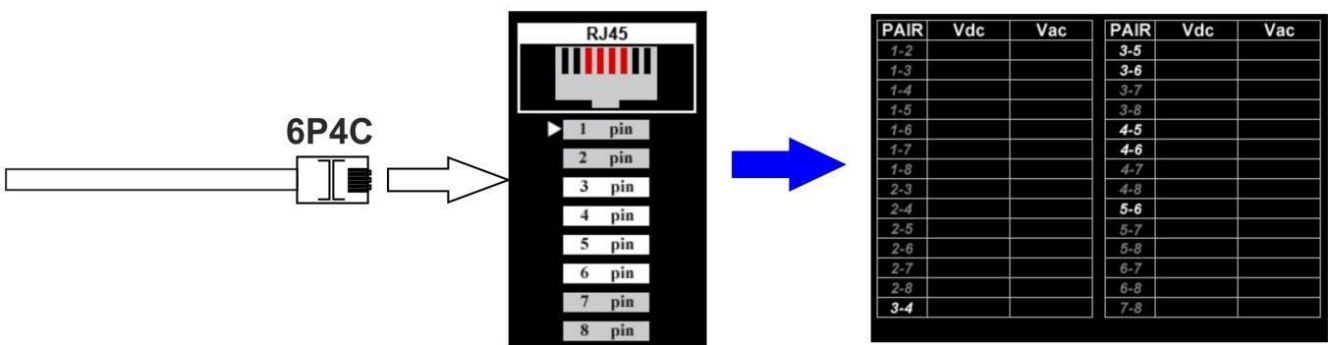

6P2C connecting ("F4")

2-wire telephone line (equipped with RJ25 or RJ11)

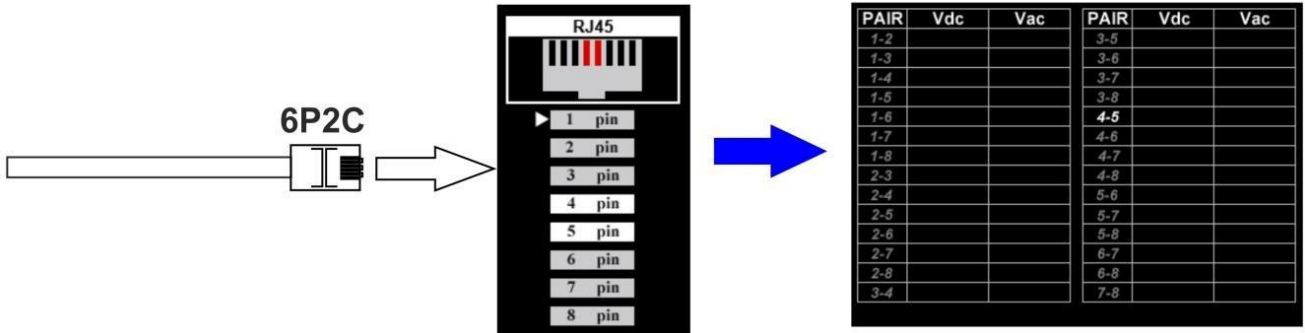

Manual setup of the electronic switch (⏏, ⏏ and "ENTER")

Settings for an arbitrary 4-wire line, not equipped with a connector (connection through RJ45 adapter)

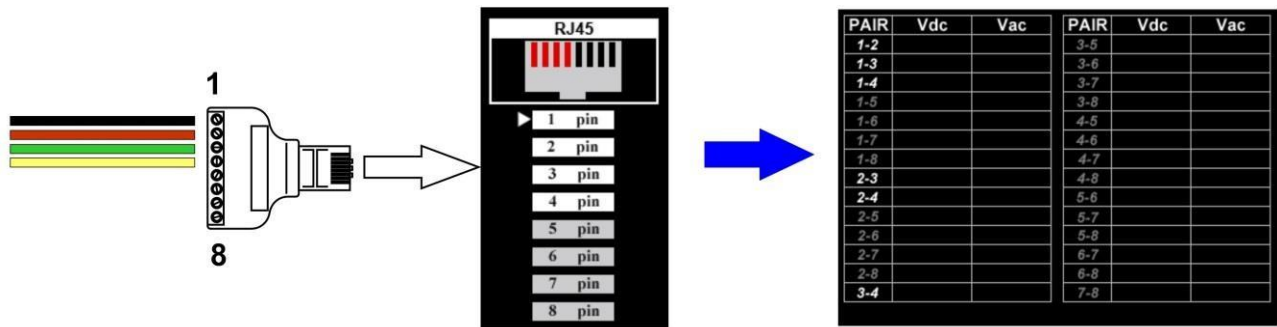

12. SUPPLEMENT #3. REFERENCE INFORMATION.

12.1. "TWISTED PAIR" CABLE

A twisted pair cable is a type of cable that consists of one or several twisted pairs, *i.e.*, insulated conductor strands twisted together with relatively few windings per length unit and enclosed in an outer plastic casing.

Twisting helps increase consistency between two cores of a pair (as electromagnetic interference from external sources will affect them equally) and to reduce electromagnetic interference, both external and mutual, when differential signals are being transmitted.

In order to reduce interaction of different pairs in a bundled twisted pair cable, cables of the 5th category or higher utilize twisted pairs with different numbers of windings per length unit.

Twisted pair cables are widely used in telecommunications and computer networking, and most typically consist of one, two, or four twisted pairs.

12.2. RJ CONNECTORS

RJ (Registered Jack) is a standardized physical network interface comprising both connectors ('plug' and 'socket') and their connection scheme. It is widely used in telecommunications. The most common standards of this kind are RJ11, RJ14, RJ25, and RJ45.

Standard	Scheme	Number of pins	Purpose
RJ9	4P4C	4	connecting telephone handsets to their bases
RJ11	6P2C	2	connecting two-wire telephone sets to the network
RJ12	6P6C	6	connecting 6-wire telephone sets
RJ11	6P4C	4	connecting 4-wire telephone sets
RJ21	50-pin	50	connecting PBX's or other telecom equipment (sometimes also called "Telco" or "Amphenol")
RJ25	6P6C	6	connecting 6-wire telephone sets
RJ45S	8P4C with key	4	connecting modems
RJ45	8P8C	8	creating local area networks
RJ50	10P10C	10	used by UPS units made by American Power Conversion and Eaton Corporation

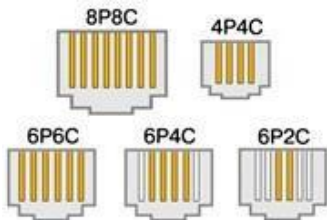

In the notation "xPyC", the letter "P" stands for 'Positions' in a plug, and "C", for "Contacts" in a socket.

12.3. WIRING SCHEME OF A FOUR TWISTED PAIR CABLE

For 10Base-T and 100Base-T Ethernet standards, four cores (orange and green pairs) are used, while the remaining four are reserved for the Gigabit Ethernet (1000Base-T) standard. There are two wiring schemes, 568A and 568B. The latter is more frequent.

12.3.1. EIA/TIA-568A WIRING SCHEME

1 st connector #	Color of wire	2 nd connector #
1	white and green (TX+)	1
2	green (TX-)	2
3	white and orange (RX+)	3
4	blue	4
5	white and blue	5
6	orange (RX-)	6
7	white and brown	7
8	brown	8

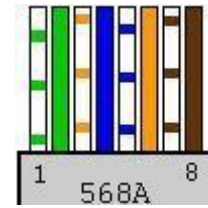

12.3.2. WIRING SCHEME EIA/TIA-568B

1 st connector #	Color of wire	2 nd connector #
1	white and orange (TX+)	1
2	orange (TX-)	2
3	white and green (RX+)	3
4	blue	4
5	white and blue	5
6	green (RX-)	6
7	white and brown	7
8	brown	8

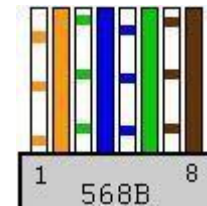

12.4. CROSSOVER WIRING SCHEME

The wiring scheme of a cable linking two network interface cards is different in that the green and orange pairs have their places swapped at one end of the cable, one of the connectors being 586A, and the other 586B. This is called a "crossover", or "null-hub" cable. The same scheme is used for cascading (connecting) hubs.

1 st connector #	Color of wire	2 nd connector #
1	white and green (TX+)	3
2	green (TX-)	6
3	white and orange (RX+)	1
4	blue	4
5	white and blue	5
6	orange (RX-)	2
7	white and brown	7
8	brown	8

A crossover connection between two computers is also possible as illustrated in the tables below, but such connections are rare.

1st connector #	Color of wire	2nd connector #
scheme 1		
1	white and green (TX+)	3
2	green (TX-)	6
3	white and orange (RX+)	1
4	blue	7
5	white and blue	8
6	orange (RX-)	2
7	white and brown	4
8	brown	5
scheme 2		
1	white and orange (TX+)	3
2	orange (TX-)	6
3	white and green (RX+)	1
4	blue	7
5	white and blue	8
6	green (RX-)	2
7	white and brown	4
8	brown	5

12.5. WIRING SCHEME OF A THREE, TWO, AND ONE TWISTED PAIR CABLE

RJ connector pin #	RJ25	RJ14	RJ11	Contemporary coloring	Obsolete coloring
1	X			white and green	orange
2	X	X		white and orange	black
3	X	X	X	blue	red
4	X	X	X	white and blue	green
5	X	X		orange	yellow
6	X			green	blue

12.6. REFERENCE INFORMATION ON TELEPHONE LINES

There are: analog, hybrid, and digital PBXs

- in circuits of analog PBXs signals are transmitted in the analog form
- in a digital PBX, the voice signal is converted into digital signal
- in a hybrid PBXs, analog signal in the speech frequency band is transmitted without conversion.

The term "hybrid" means that system and analogue phone sets can be plugged in.

Line type	Purpose	User device
two-wire analogue	municipal telephone line, office PBX analogue line	analogue telephone
two-wire digital	office PBX digital line	digital telephone
four-wire digital	office PBX digital lines	digital system telephone
four-wire hybrid	office PBX hybrid lines	analogue system telephone

PAIRS OF WIRES USED IN TELEPHONE CIRCUITS

line type	RJ connector	RJ connector pin #	Wire coloring	
			Modern	Obsolete
2-wire analog	RJ-9	2-3 – analog signal	green orange	red green
	RJ-11/14/25	3-4 – analog signal	white and blue blue	red green
2-wire digital	RJ-11/14/25	3-4 – digital signal	white and blue blue	red green
4-wire digital	RJ-14/25	3-4 – digital signal	white and blue blue	red green
		2-5 – PBX commands	white and orange orange	black yellow
4-wire hybrid	RJ-14/25	3-4 – analog signal	white and blue blue	red green
		2-5 – PBX commands	white and orange orange	black yellow